



This is a digital copy of a book that was preserved for generations on library shelves before it was carefully scanned by Google as part of a project to make the world's books discoverable online.

It has survived long enough for the copyright to expire and the book to enter the public domain. A public domain book is one that was never subject to copyright or whose legal copyright term has expired. Whether a book is in the public domain may vary country to country. Public domain books are our gateways to the past, representing a wealth of history, culture and knowledge that's often difficult to discover.

Marks, notations and other marginalia present in the original volume will appear in this file - a reminder of this book's long journey from the publisher to a library and finally to you.

Usage guidelines

Google is proud to partner with libraries to digitize public domain materials and make them widely accessible. Public domain books belong to the public and we are merely their custodians. Nevertheless, this work is expensive, so in order to keep providing this resource, we have taken steps to prevent abuse by commercial parties, including placing technical restrictions on automated querying.

We also ask that you:

- + *Make non-commercial use of the files* We designed Google Book Search for use by individuals, and we request that you use these files for personal, non-commercial purposes.
- + *Refrain from automated querying* Do not send automated queries of any sort to Google's system: If you are conducting research on machine translation, optical character recognition or other areas where access to a large amount of text is helpful, please contact us. We encourage the use of public domain materials for these purposes and may be able to help.
- + *Maintain attribution* The Google "watermark" you see on each file is essential for informing people about this project and helping them find additional materials through Google Book Search. Please do not remove it.
- + *Keep it legal* Whatever your use, remember that you are responsible for ensuring that what you are doing is legal. Do not assume that just because we believe a book is in the public domain for users in the United States, that the work is also in the public domain for users in other countries. Whether a book is still in copyright varies from country to country, and we can't offer guidance on whether any specific use of any specific book is allowed. Please do not assume that a book's appearance in Google Book Search means it can be used in any manner anywhere in the world. Copyright infringement liability can be quite severe.

About Google Book Search

Google's mission is to organize the world's information and to make it universally accessible and useful. Google Book Search helps readers discover the world's books while helping authors and publishers reach new audiences. You can search through the full text of this book on the web at <http://books.google.com/>

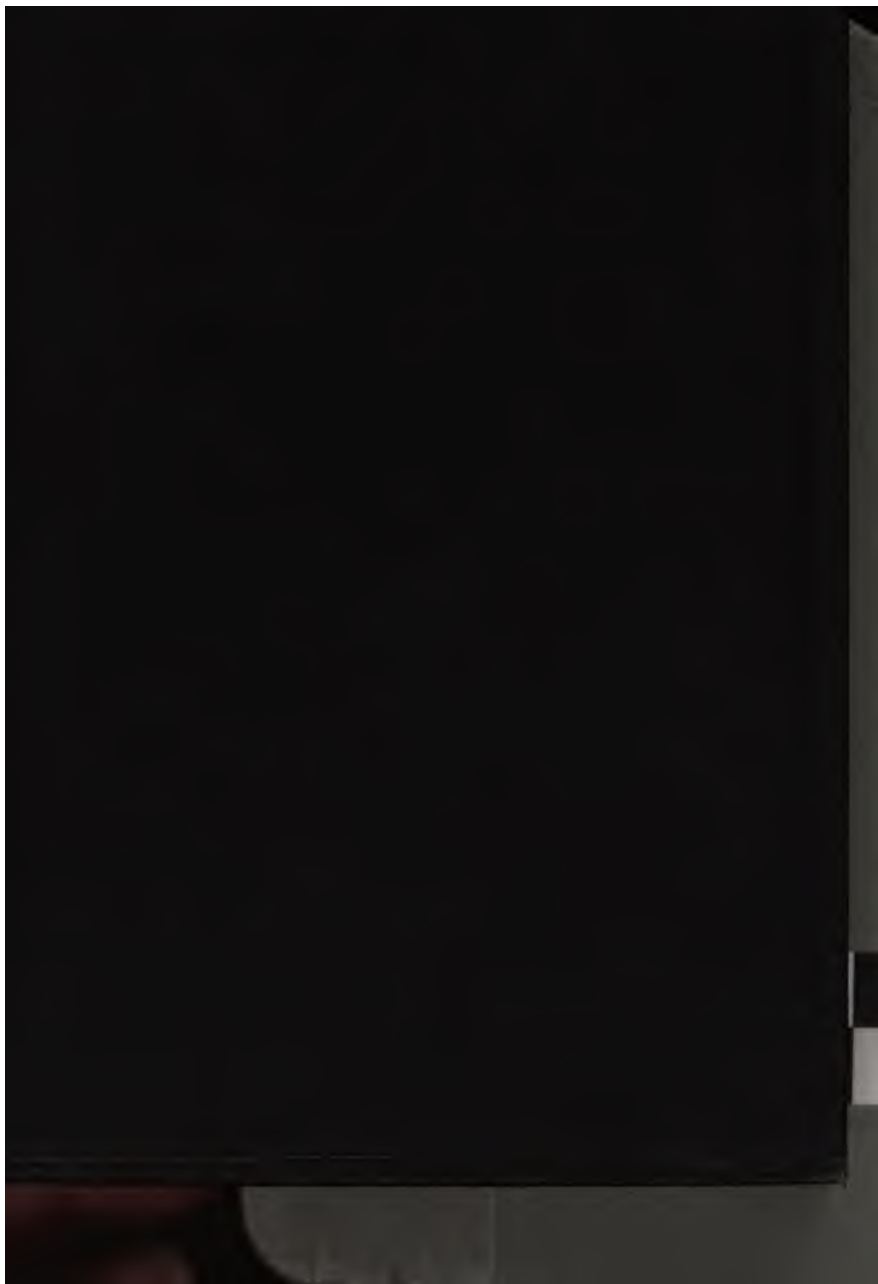

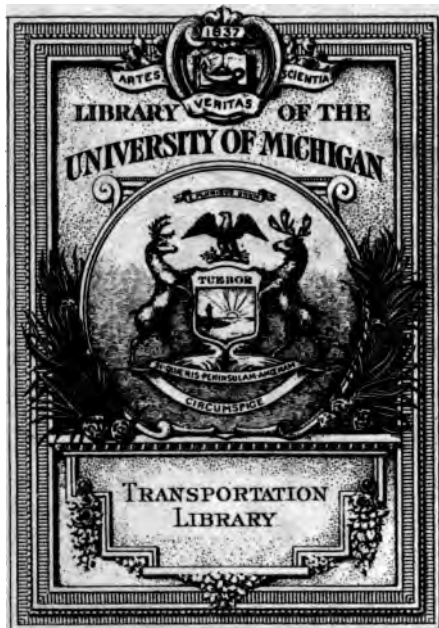

Transportation
Library

S
607
745

1

CLEARING AND GRUBBING

WORKS OF HALBERT P. GILLETTE

Handbook of Cost Data

A reference book giving methods of construction and actual costs of material and labor on all kinds of engineering works. 1900 pages. 16 mo., flexible binding, 4¾ x 7. \$5.00

Handbook of Rock Excavation

A practical treatise on drilling, excavating, quarrying and handling rock. 809 pages, 200 illustrations, flexible binding, 4¾ x 7. \$5.00

Handbook of Earth Excavation

A practical treatise on the excavation and handling of earth. Over 800 pages, illustrated, flexible binding, 4¾ x 7. \$5.00

JOINT AUTHOR WORKS

Cost Keeping and Management Engineering

By Halbert P. Gillette and Richard T. Dana
A treatise for civil engineers and contractors. 360 pages, 184 figures, 5 x 8. \$3.50

Concrete Construction, Methods and Cost

By Halbert P. Gillette and Chas. S. Hill
A treatise on concrete and reinforced concrete structures of every kind. 700 pages, 306 figures, 6 x 9. Cloth. \$5.00

HANDBOOK OF CLEARING AND GRUBBING METHODS AND COST

BY

HALBERT POWERS GILLETTE

Member American Society of Civil Engineers
Member American Institute of Mining Engineers
Member American Society of Mechanical Engineers
Member Society for the Promotion of Engineering Education



NEW YORK

1917

COPYRIGHT 1917

BY . . .

CLARK BOOK COMPANY, INC.

Transcript
15111
15111

PREFACE

More than half the tillable area of the United States was originally forest. East of the Mississippi there was comparatively little arable land not covered with trees 200 years ago. Of the 400,000,000 acres of farm land now under cultivation, it is a conservative estimate that 50 per cent had to be cleared and stumped before it could be cropped. Assuming, then, that 200,000,000 acres of farm land in America have been cleared and grubbed at an average cost of only \$10 an acre, there has been expended \$2,000,000,000 for this work. The staggering size of this sum would naturally lead a person to expect to find many books on the subject of clearing and grubbing, but the present book is the first and only one of its kind.

By state and federal departments of government there have been published a number of valuable bulletins on the subject, but in none of these is there to be found even a general review of all the different methods of clearing trees and removing stumps. Beside collecting into this book all the valuable information contained in bulletins, I have also compiled all that I could find in periodical literature. In addition I have abstracted from catalogs of manufacturers a considerable amount of excellent material.

I have published several original articles in *Engineering and Contracting*, the contents of which will be found herein. As an engineering contractor I have had charge of clearing and grubbing operations under some of the most difficult conditions. I have built stump pullers capable of exerting a strain of 100,000 lbs. I have blasted out fir stumps 12 ft. in diameter above the ground level, and have done clearing and "stumping" under such severe conditions that the cost was \$400 an acre after the standing timber had been cut and logged off. These facts are mentioned to give the reader at least some measure of my competence to write on the subject and to compile with judgment what others have written

PREFACE

In the work of compilation I have been ably assisted by Mr. Arthur P. Ackerman.

Wherever possible the costs of clearing and grubbing have been given in such detail that the reader will be able to substitute the rates of wages and prices of materials prevailing in his own locality. It is often said that cost data that have not been recently gathered are almost valueless. This is one of those erroneous generalizations that pass for full-flowered truth because there is a seed of truth in their make-up. Prices of materials and rates of wages do change, and often quite rapidly, but if cost data are presented in sufficient detail, due allowance for such changes can be readily made by the reader. Of course where methods and machines have been greatly improved, old cost data may be valueless; but it is particularly true of clearing and grubbing that there have been no very noteworthy improvements in recent years. Such as have occurred are fully described in this volume, and several of them are so meritorious under certain conditions as to be actually revolutionary in their character. For example, there is the method of "char-pitting" for the removal of large stumps. The use of power-driven augers is another innovation well worthy of careful consideration. The piling of stumps and logs around a mast, with the aid of cables and a donkey engine, is another noteworthy method that is relatively new.

My residence in western Washington gave me the opportunity to see nearly all the methods herein described and to use many of them myself. I am convinced that there is opportunity for vastly improving even the best that has been yet accomplished in the removal of stumps. In Washington, Oregon and California there are 850,000 acres of logged-off land where stumps are still standing. This presents a reclamation problem that may well claim the attention of the best engineering talent. Yet because clearing and grubbing have so long been regarded as somewhat beneath an engineer's consideration, engineers are slow in awakening to the great opportunities that here present themselves.

HALBERT POWERS GILLETTE.

New York City, March 15, 1917.

CONTENTS

| CHAPTER | PAGE |
|--|------|
| GLOSSARY OF TERMS | 1 |
| I. COST ESTIMATING AND APPRAISING | 5 |
| Factors in Clearing and Grubbing Costs, 5-9; Estimating Clearing and Grubbing Costs, further factors affecting costs, 9-16. Appraisals and Valuations, 16-18. | |
| II. SPECIFICATIONS | 19 |
| Criticism of Specifications, 19-23. Legal decision relating to Clearing and Grubbing, 24. Specifications for Clearing and Grubbing on roads, 24-28. Specifications for Clearing and Grubbing on dams and reservoirs, 28-31. Specifications for Clearing and Grubbing on railways, 31-34. | |
| III. CLEARING | 35 |
| Land clearing practice, 35-37. Tools, 37-39. Methods and Costs in Minnesota, Comparison of Methods of clearing, 39-52. Treatment of land after clearing, 52-54. Examples of cost, 54-57. Cord wood, 58-59. | |
| IV. GRUBBING BY HAND | 60 |
| Tools, 60. Grubbing helped by frost and high wind, 61-62. Examples of cost, 62-67. | |
| V. BURNING AND CHAR-PITTING | 68 |
| Burning aided by boring, 68-69. Char-pitting, 70-75. Portable stoves, 75-76. Blowing machine, 76-78. Distilling stumps in place, 89. | |
| VI. BLASTING | 92 |
| Kinds of explosive, 92. Tools and methods, 93-101. Placing charge, 101-109. Amount of explosive to use, 109-111. Boring stumps for blasting, 111-115. Examples of costs, 115-136. | |

CONTENTS

| CHAPTER | PAGE |
|---|------|
| VII. HAND, HORSE AND POWER STUMP PULLERS | 137 |
| Cost of stump pullers, 137-138. Man power stump pullers, 138-145. Horse power stump pullers, 145-151. Method of hitching to stumps, 151-162. Power stump pullers, 162-194. Examples of cost, 194-227. | |
| VIII. HEAVY PLOWS | 228 |
| Special Plows, 228-229. Examples of Cost of Plowing Brush, 229-232. | |
| DIRECTORY OF MANUFACTURES | 233 |
| INDEX | 235 |

GLOSSARY OF TERMS

Definitions of words. The following are some of the common terms used by woodsmen and others engaged in clearing and stumping.

Barking or *Rossing* are terms used for the operation of removing the bark from one side of logs or from the entire log. This work is done to reduce friction in skidding. It includes cutting off knots and projections that would interfere with the progress of the log.

Brutting is a term used to designate the operation of hauling and rolling logs by hand from the stump to a point where other means of transportation can be secured.

Bucking is the operation of cutting the tree up into logs. This is done with power-driven saws in some parts of the country.

Bucker. A man who cuts up trees into logs. A "wood bucker" is a man who gets fire wood for operating a donkey engine.

Bull Cook. A man who does chores for the cook.

Chaser. A man who removes a line or "choker" from a log at the place it is landed.

Choker. A rope or chain that is slung around a log or stump. A "choker man" is one who places a line around a log.

Clearing. This term is used by civil engineers to denote the falling and removing of trees and brush, but not the removing of stumps which they call grubbing. But farmers usually apply the term "clearing" to stumping and burning stumps, as well as to cutting down trees and brush.

Deadening or *Girdling* consists in cutting a ring around the tree deep enough to penetrate to the heart wood. This ring is made just above the root swelling approximately at the sawing point. In cypress swamps

girdling which precedes felling from a few weeks to several months is generally done by contract for 7 or 8 cents a tree. One man will girdle about 25 trees a day.

Faller. A man who cuts down, or "falls" trees. A logging gang has a "head faller" and a "second faller."

Felling or *falling* is the operation of cutting down the tree. Contract felling and log making in lodge-pole pine ranges from \$1.25 to \$2.00 per thousand feet; in yellow pine and cypress from 35 to 50 cents; in fir from 50 to 80 cents.

Flunkey. A waiter in a camp.

Grubbing. Civil engineers use grubbing to denote the removal of stumps and roots, whether by blasting, pulling, or otherwise; and it is often specified that the term "grubbing" is to include burning the stumps. A synonymous word is "stumping."

Notching is a term that includes marking the trees which are to be felled, making the undercut for the fallers, and marking the log lengths on the fallen tree.

Ranking. Arranging regularly in piles.

Rigging Slinger. The man who changes and places the wire cables used in handling logs.

Scaling is measuring logs to determine their contents in ft. B. M.

Slashing is the debris left after logging.

Snaking or *skidding* is the operation of dragging logs end foremost from the point where cut to a river, logging railroad or other means of transportation.

Sniping. Previous to skidding the forward end of a large log is "sniped" or "nosed." This consists in rounding off the under side of the log so that it will not catch on obstructions. Where the ground is rough and the log is likely to roll over, the entire front end is sniped.

Stumping. Removing stumps. See "grubbing."

Stumping Powder. A dynamite low in nitro-glycerin.

Swamping is cutting the limbs from the fallen tree. The term is also used to include clearing away brush and limbs to make skidways.

Yarding. Piling the logs preparatory to loading and hauling away.

GLOSSARY OF TERMS

The foregoing definitions are taken partly from author's experience and partly from "Logging," Ralph Clement Bryant (1913), in which will be found a very complete glossary of logging terms.

CLEARING AND GRUBBING

CHAPTER I

COST ESTIMATING AND APPRAISING

Factors in clearing and grubbing cost. *Clearing* consists in cutting down and removing or burning trees and brush, except the stumps. *Grubbing*, or stumping, consists in excavating and removing stumps. The unit of measure is usually the acre, but occasionally the square rod (160 per acre), and at other times the "great square" (100 x 100 ft.), is the unit of measure for grubbing. In railroad work, a "station" of 100 ft. in length and a width equal to that of the right of way is usually the unit of clearing.

In clearing trees, the following are important elements affecting the cost per acre:

1. Number of trees per acre.
2. Average diameter.
3. Average height.
4. Kind of tree.
5. Density of wood.
6. Whether the logs and limbs are cut up and hauled off, or are chopped into cordwood, or are burned.
7. Weather conditions.
8. Efficiency of workmen and wage rate.
9. Size of job.

Unfortunately no published record of the cost of clearing gives all these factors, but many give a sufficient number of the factors to guide the reader sufficiently well.

In grubbing stumps, the following are important elements affecting the cost per acre:

1. Number of stumps per acre.
2. Average diameter at cut-off.
3. Kind of tree.
4. Green or dead.
5. Kind of earth and degree of wetness.
6. Pulled or blasted.
7. Type of roots.
8. Burned or hauled away.
9. Weather.
10. Ground frozen or not.
11. Efficiency of men and wage rate.
12. Size of job.

In addition to the above factors the cost of excess excavation required to fill stump holes under embankments must be taken into consideration.

Types of roots. *Tap roots* are the most difficult to pull or blast. The long-leaf yellow pine of the south is typical of this class. Hickory, white oak and black gum also have tap roots.

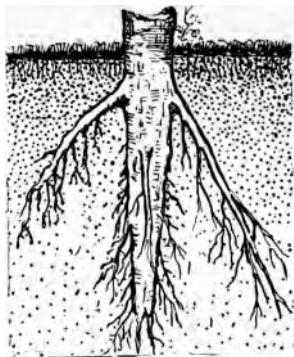

Fig. 1. Tap Root

Semi-tap roots are the most common variety. The class includes white pine, poplar, chestnut, ash, walnut, persimmon, sassafras, various varieties of oak and most fruit trees.



Fig. 2. Semi-Tap Roots

Lateral root trees are less numerous than other kinds. This class includes elm, soft maple, locust, hemlock, dogwood and elder. These three types of roots merge into each other. Soil conditions also affect the form of root growth so that an absolute classification is not possible.



Fig. 3. Lateral Roots

Effect of age on stumps. The following is from Mr. J. R. Mattern's bulletin on "Clearing Land of Stumps":

Some stumps are durable and others will rot very fast. White pine, Norway pine, locust and cedar stumps will last fifty years without decaying enough to make much difference in the work of their removal. Chestnut, white oak and catalpa are nearly as durable. The other oaks, poplar, ash, hemlock, hickory and gum rot so fast that in a few years a team of horses can roll out stumps of considerable size. A stump that does not sprout is not getting any worse as time passes, but one that does sprout is likely to be harder to take out each succeeding season.

For accurate estimates of the cost of either clearing or grubbing, the number of trees per acre should be known approximately. If the trees are classified according to size, more accurate estimating becomes possible. Much yet remains to be printed relative to clearing and grubbing costs per tree of different kinds before an entirely inexperienced man can make a very close estimate of costs per acre.

With different spacing of trees, assuming them to be set at the corners of squares, the following table gives the number of trees per acre:

TABLE I

| Distance apart, feet | Trees per acre |
|----------------------|----------------|
| 10 | 436 |
| 12 | 302 |
| 14 | 222 |
| 16 | 170 |
| 18 | 134 |
| 20 | 109 |
| 25 | 70 |
| 30 | 48 |
| 40 | 27 |
| 50 | 17 |

In ordinarily dense woods there are 100 to 250 trees per acre.

In chopping or sawing trees the amount of work varies about as the square of the diameter. Hence assuming a 12-in. tree as unity, we have the following ratios of cost of cutting down trees of different diameters:

TABLE II

| Diameter, Inches | Per cent of difficulty | Relative section to be cut |
|---------------------|---------------------------|-------------------------------|
| 6 | 25 | $\frac{1}{4}$ |
| 8 | 44 | $\frac{1}{2}$ |
| 12 | 100 | 1 |
| 18 | 225 | $2\frac{1}{4}$ |
| 24 | 400 | 4 |
| 30 | 625 | $6\frac{1}{4}$ |
| 36 | 900 | 9 |
| 42 | 1225 | $12\frac{1}{4}$ |
| 48 | 1600 | 16 |

Therefore the work done in cutting down a 48-in. tree is 16 times as great as that on a 12-in. tree of the same

kind. If done entirely by hand, the total labor of clearing away a 48-in. tree will be more than 16 times that required by a 12-in. tree for the trunk will be longer requiring to be cut into more sections before it can be moved. Also trees of such large diameter are difficult to handle with a cross-cut saw so that even the difficulty of falling increases at a greater rate than the square of the diameter.

Even a casual consideration of the significance of the two foregoing tables will make clear the importance of stating the number of trees of each size, per acre. It does not suffice to say in a given case that the trees ranged from 12 in. to 48 in. without indicating the approximate number of each size.

Nor is it satisfactory to state an average diameter. A "weighted diameter" may be given that will serve for cost estimating purposes. This is to be obtained by multiplying the square of the diameter of each size of tree by the number of trees of that size. The sum of all the products so obtained is to be divided by the total number of trees and the square root extracted. This gives a "weighted diameter." In effect this is equivalent to listing the number of trees of each size and may not prove so satisfactory.

The quantity of timber on an acre is frequently stated as so many thousand feet board measure, expressed M. ft. B. M. The unit is a board 1 ft. square by 1 in. thick. A cu. ft. of wood contains 12 ft. B. M. Various rules exist for measuring or estimating the ft. B. M. in a saw log. According to the Woodman's Handbook by Prof. H. S. Graves published as bulletin 36 of the Bureau of Forestry, U. S. Department of Agriculture, Washington, D. C., more than 30 different log rules are in use in the United States. All these rules profess to provide means for ascertaining the number of ft. B. M. which can be sawn from a log of given diameter and length. This bulletin compares the principal log rules.

Suggestions as to estimating costs of clearing and grubbing. In *Engineering and Contracting*, Sept. 6, 1911, the author published the following:

Any one who has not seen the trees of western Wash-

ington and Oregon may find it difficult to believe that clearing and grubbing has often cost more than \$500 an acre in that section of the country. Yet on a recently built electric railway along Puget Sound the cutting of trees and yarding the logs on the right of way ready for loading cost \$280 per acre, and the subsequent pulling of stumps, stacking and burning of all refuse on the right of way cost \$300 per acre, making a total of \$580 per acre for logging, clearing and grubbing.

Mr. Harry Thomson states that there are 2,352,000 acres of logged-off land in Washington, and 5,034,000 acres of standing merchantable timber. Probably not less than 1,000,000 acres of the present logged-off land would be in cultivation today were it possible to clear and grub it cheaply. Data given by Mr. Thomson indicate that this clearing and grubbing might average a cost of \$150 an acre, with present methods. But even as low a cost as \$100 an acre would mean the expenditure of \$100,000,000 to reclaim 40 per cent of the present logged-off lands in Washington. When one realizes that every dollar that can be eliminated from the cost per acre of this work means a million dollars saved to the community, the importance of this problem in engineering economics begins to loom large; and when it is appreciated that adequate engineering investigation and supervision may reduce the cost by \$50 an acre, the clearing and grubbing problem takes on the dignity of the greatest of reclamation projects.

Mr. Thomson gives a table showing the number of sticks of powder required to blast out stumps of different diameters. We wish to call attention to the fact that the amount of explosive varies almost exactly as the square of the diameter of the stump. This is an exceedingly important fact, for it serves to indicate how it may become possible to estimate with considerable accuracy the cost of grubbing under any given conditions. If we pause a moment to consider the matter, we see that the resistance offered by a stump must vary as some higher power of its diameter, and probably about as the square thereof; for the cross-sectional area

of the wood in the tree itself varies as the square of the diameter, and the area covered by the roots probably varies in similar ratio. To saw down a tree 2 ft. in diameter requires about 4 times the labor required on a tree 1 ft. in diameter. To fell a 3-ft. tree requires 9 times the labor required on a 1-ft. tree. Similarly, the amount of explosive needed to blow out the stump will probably increase as the square of the diameter increases. But it does not necessarily follow, of course, that the labor of pulling stumps will increase in the same ratio, for, by the use of a powerful stump pulling device operated by an engine, it may take but little more labor to pull a 2-ft. stump than it takes to pull one of half that diameter.

In all likelihood, the strain that a stump puller should develop should be proportionate to the square of the diameter of the stump.

It is clear that no accurate estimate of the acre cost of removing stumps can be made until at least two elements are known: (1) The number of stumps per acre, and (2) the weighted diameter of the stumps. By "weighted diameter" we do not mean the average diameter, but the weighted average for cost estimating purposes. To illustrate, suppose there are 30 stumps per acre, 20 of which measure 12 ins. in diameter at the cut-off (all diameters should be given at the cut-off and not at the ground level), and 10 of 30-in. diameter. Then the average diameter would be calculated thus:

| | Total Diam. |
|--------------------|-------------|
| 20 at 12 ins. | = 240 ins. |
| 10 at 30 ins. | = 300 ins. |
| 30 at 18 ins. | = 540 ins. |

If we assume that the cost of blasting stumps varies as the square of the diameter, the weighted diameter for cost estimating purposes is calculated thus:

| | Total Squared Diam. |
|--|------------------------|
| 20 at (12 ins. × 12 ins.) = | 2,880 |
| 10 at (30 ins. × 30 ins.) = | 9,000 |
| 30 at nearly (20 ins. × 20 ins.) = | 11,880 |

This gives nearly 20 ins. as the weighted diameter for cost estimating purposes.

Having estimated the number of stumps per acre and their weighted diameter, it is possible to approximate the cost of blasting them out. To this must be added the cost of piling and burning them, which, it is altogether probable, can be reduced to a unit cost per stump of given size that will make accurate estimating possible. Fallen logs may be estimated in cords of wood per acre, and the cost of piling and burning them may then become a matter of quite accurate forecast.

In estimating clearing and grubbing, as in estimating any other costs, the primary object should be to measure the work in units that are true functions of the cost. By itself the acre of clearing and grubbing is not a satisfactory unit for measuring costs. The thousand feet board measure is a suitable unit in which to express the cost of felling trees, making them into logs and loading onto cars, wagons, etc. The stump of a given size is the proper unit in which to express the cost of grubbing stumps. The cord or cubic foot of wood may be a suitable unit in which to express the cost of piling and burning. Other units may be desirable. It is clear that existing cost data on clearing and grubbing are defective, for the most part, because they are not recorded in proper units.

Effect of method of excavation on cost of grubbing. *Engineering and Contracting*, Dec. 25, 1907, gives the following: One of the items of work to be done in grading a railroad is generally the clearing and grubbing of the land. Under some contracts and specifications this work is paid for as one item, under others as two items as clearing and as grubbing, while under other forms of contracts this work is included in that of excavation.

The method of paying for clearing by the acre as one item and grubbing as another item is to be commended. In order to do the excavation all the land must be cleared, but in addition to the area used for the cuts and embankments, the entire width of the right of way must be cleared, and overhanging trees and branches must be

cut away. On the other hand there is no need of grubbing the area occupied by the embankments, nor that on the right of way not included in the cuts, hence there should be no reason why this area should be included in the payment. Likewise the method of doing the excavation will very materially effect the cost of the grubbing, while it does not play any part in the cost of clearing.

When a steam shovel is used the grubbing cost is small, as this machine will undermine the stumps, causing them to fall into the pit, where they can be loaded onto the cars by means of chains, attached to the dipper teeth. This work retards the progress made by the shovel, but the cost of grubbing is greatly reduced, and a contractor could afford to bid a low price on the grubbing when done with a steam shovel, if it is not lumped in with the clearing or other work.

When grubbing is done in connection with rock excavation, its cost is small as the stumps are shot out with the blasting of the rock, and the only additional expense is to dispose of the stump. This will have to be done by hand and will be work that the contractor will charge for under grubbing.

When grubbing is done for scraper work the stumps and largest roots must be blasted and dug out, and the work is much more expensive than with rock excavation and steam shovel work, although a large railroad plow in loosening the ground will cut and break up many of the roots, so that they do not have to be grubbed.

The grubbing for elevating grader excavation must be done much more thoroughly than that for scraper work. The stumps and large roots must not only be grubbed, but all the small bush stubs and roots must also be cut out. This is necessary as the grader plow will not cut these roots, as the pull on the plow is a steady one, unlike that of a breaking plow, which can be run in jerks, while the plowman can shake up the plow, which is a considerable help. In grubbing for a grader it is not advisable to blast the stumps, as this makes large deep holes, which, after rains, become full of water and soft, thus causing the traction engine and grader to mire in these holes. For this reason where there are many stumps of 6 ins

or more in size a stump puller should be used. For elevating grader work the stump puller does its work much better than blasting, as it will not only pull up the stump, but also all the large roots and many of the small ones. Nor does it leave as large a hole as a blast does. Its work is as economical as blasting, and at times is much cheaper. The small stumps and roots must all be grubbed by hand. To do efficient work of grubbing for a grader, after the large stumps have been pulled, men should be spaced a few feet apart and the entire area gone over, the men working in rows grubbing up everything that may effect the working of the grader. This makes grader grubbing more expensive than that of any other grubbing for ordinary excavation work.

Loss of material due to grubbing. Mr. F. W. Harris, in *Engineering News*, Dec. 17, 1914, says that in timber country 10% of the total excavation can be considered as worthless, as it consists of humus, rock, logs, roots, etc., and another 10% should be deducted for quantities lost in blasting stumps. These percentages should be increased to 15% in each instance where excavation averages less than a 3-ft. cut. Percentages also vary with the locality. In the Bitter Root Mountains in Idaho, they would be about 5%; while on the western slope of the Cascades on the Washington and British Columbia Coast, 15% would not be too high in each case.

Estimating Shrinkage. F. W. Harris, in *Engineering News*, Dec. 23, 1915, gives the following data:

The method of obtaining an estimate of shrinkage in a timber country is as follows: Plot a trial grade line on the profile, seeing that the quantities balance reasonably close. The excavation should exceed embankment at least 10%. The profile will give the center cut and fill, and an experienced man can stand on the center line and estimate where the slopes will intersect the ground line.

The stumps in each station should be noted and recorded according to sizes and kinds of stump, also the formation of soil, whether rock, gravel or swamp. It is *essential to note* the kind of stumps, as some stumps will

blow out much easier than others. For instance, a 4-ft. fir stump will leave a smaller hole than a 4-ft. cedar stump. This should be borne in mind merely as it would be a useless refinement to grade the loss of excavation by the kind of stump shot out. In the office the stumps should be listed according to cuts and fills.

The following table will apply on the Pacific Northwest Coast for computing loss of excavation by blowing out stumps. Fir, cedar, spruce, hemlock are averaged in the table.

| | |
|-------------------|-----------------|
| 6 to 12 in. | 1 cu. yd. each |
| 12 to 24 in. | 3 cu. yd. each |
| 24 to 36 in. | 5 cu. yd. each |
| Above 36 in. | 10 cu. yd. each |

In swamps where the growth is spruce, hemlock, cedar, maple, 50% should be added to these quantities, as it requires more dynamite to lift a stump of given size, owing to the decreased resistance of the swamp soils. To get shrinkage, say between Sta. 20 and 30, which would average a 4-ft. cut on the center line for the entire distance. Assuming the record shows the soil to be clay and hardpan, and the list of stumps for this section to total 65, divided as follows:

| | | |
|-------------------|-------|-------------|
| 6 to 12 in. | 20 | 20 cu. yd. |
| 12 to 24 in. | 20 | 60 cu. yd. |
| 24 to 36 in. | 20 | 100 cu. yd. |
| Above 36 in. | 5 | 50 cu. yd. |
| | <hr/> | <hr/> |
| | 65 | 230 cu. yd. |

In this cut the grade line would have to be lower to give the additional 230 cu. yds. lost in blasting. As the same condition, however, is assumed to exist in the adjacent fill, the grade line will give a correct balance.

The grubbing clause should be revised to include the following:

All stumps and roots on the right-of-way to be grubbed will be paid for according to the list of sizes shown on the schedule of quantities. Stumps 6 to 24 in. will be measured 4 ft. above the ground, stumps over 24 in. diameter will be measured at the butt log or on top of stump.

Estimating small tracts of standing timber. (*Engineering and Contracting*, July 22, 1914.) The following method of estimating small tracts of timber is recommended by the New York State College of Forestry:

(1) Count all the trees in a circle 118 ft. across; $\frac{1}{4}$ acre. (2) Select a sample tree as nearly average as you can. (3) Determine how much of the tree you can saw (or use for any purpose) in 16-ft. logs (8-ft. logs count as halves). (4) Add the top and bottom diameters inside the bark, and divide by two. (Only solid wood considered, bark excluded.) This will give you the average diameter of the used length. (5) Square average diameter thus obtained, subtract 60, multiply by 0.8 and you will have the contents of an average 16-ft. log. (6) Multiply by the number of logs in the tree and then by 4 times the number of trees on your plot (since $\frac{1}{4}$ acre plot was used) and you will have the contents of that acre in board feet. *Example.*—Basswood, 85 ft. total height, can saw 40 ft. of it ($2\frac{1}{2}$ logs). Top diameter inside the bark, 10 ins.; diameter of lower cut, inside the bark, 20 ins. (average diameter 15 ins.). Fifteen squared = 225; $(225 - 60) \times 0.8 = 132$ ft. B. M. contents of average log. $132 \times 2\frac{1}{2}$ logs = 330 ft. B. M. contents of tree. 10 trees on plot $330 \times 40 = 13,200$ ft. B. M. per acre. By selecting 8 to 10 sample plots in different parts of the tract the average stand per acre may be found.

Appraisal of clearing and grubbing. Instructions to Office and Field Engineers, by Engineering Committee of the President's Conference Committee on Federal Valuation, gives the following:

Clearing and Grubbing. In determining the actual quantities of clearing and grubbing the records should be carefully examined and information thus obtained supplemented by inquiries of residents and from information on the timber on the property adjacent to the right of way.

Contract prices for clearing and grubbing railways. In building the Great Northern Ry. in Washington in the early 90's contract prices for clearing ranged from \$28 an acre in the eastern part of the state

to \$140 in the western part. Grubbing contracts were let by the "station" of 100 ft. long and as wide as excavated cut, the prices ranging from \$14 a station in the eastern part to \$25 a station in the western part. In estimating the cost of reproducing the 768 miles of Great Northern line in 1907, I allowed an average price of \$100 an acre for clearing, \$20 a station for grubbing, and \$2 a tree for cutting dangerous trees alongside the right of way, and the total of these items averaged \$914 per mile of railway line. This, it should be noted, is in a country where some very heavy clearing was encountered.

In estimating the reproduction cost of 1,645 miles of Northern Pacific Ry. line in Washington, I used almost the same prices, and the total was \$867 per mile. On the other hand my estimate of the clearing and grubbing item on the 500 miles of Oregon, Railway & Navigation Co. lines amount to only \$65 per mile, for those lines were mainly in a treeless country.

In building the Chicago, Milwaukee & St. Paul lines in Washington, in 1906, the contract prices were \$40 to \$300 per acre for clearing, the average being \$120; and the price for grubbing ranged from \$10 to \$20 per station, the average being \$15. During the same period the contract prices on the double-tracking of the Portland and Seattle Ry. were \$25 an acre for clearing and \$1.50 a sq. rd. for grubbing. Since there are 160 sq. rds. to the acre, the \$1.50 price is equivalent to \$240 per acre for grubbing, a not unusual price for grubbing very large trees.

In the appraisal of railway lines in Texas, in 1906, the prices for clearing and grubbing were \$25 to \$50 per acre.

In the appraisal of the railways in Nebraska, in 1909, Mr. E. C. Hurd estimated \$20 per acre for clearing and \$50 per acre for grubbing.

Contract price grubbing and clearing 15 acres for locks and dam No. 17, Black Warrior River, Alabama, \$100 per acre. (Prof. Memoirs, May-June, 1915.)

Contract prices on the Haines-Pleasant Camp Road, Alaska: Heavy clearing, \$125; light clearing, \$100

grubbing, \$50 per acre (earth excav., 38 ct. per cu. yd.).

Trautwine gives \$50 as average cost of clearing and grubbing right of way for a railroad when wages are \$1.75 per day. Merriman gives \$25 to \$75 per acre, not stating the rate of wages.

Railroad valuation by the interstate commerce commission. The following are taken from protests against their valuation filed with the Interstate Commerce Commission:

Protest by the New Orleans, Texas and Mexico R. R.

| | Price used by Commission | Price claimed by Co. |
|---------------------------|-----------------------------|-------------------------|
| Clearing 1148 acres | \$45 | \$45 |
| Grubbing 381 acres | \$50 | \$60 |

Protest by the Texas Midland R. R.

| | | |
|--------------------------|------|------|
| Clearing 354 acres | \$25 | \$35 |
| Grubbing 42 acres | \$40 | \$52 |

Clearing road at Palatka, Fla. (*Engineering and Contracting*, May 3, 1911.) The annual report (1910) of Logan Waller Page, Director, U. S. Office of Public Roads, states that in building a new road 5,000 ft. long through forest, 400 trees and stumps were grubbed at a cost of \$233.11.

CHAPTER II

SPECIFICATIONS

Criticism of clearing and grubbing specifications.
(*Engineering and Contracting*, Sept. 11, 1907.)
Specifications frequently contain paragraphs that at first glance seem customary and extremely innocent, when in reality there is a "negro hid in the brush pile." The following clause is copied from a set of specifications for railroad construction in the south:

"The surface of the ground to be excavated, and places where embankments occur not exceeding 2 ft. in height, shall be (between slope stakes) grubbed free from stumps, roots, brush and other perishable material as directed by the engineer."

The clause covering the grubbing under low embankments is one that is in common usage, but the beginning of the paragraph can cause trouble.

Railroad excavation, when it is earth, is commonly done with scrapers, elevating graders or steam shovels. When the first two methods are used, the contractor, in order to work either his scraper or his grader, must first grub the ground free from all stumps and roots. It is a different story when a steam shovel is operated. Then the shovel can dig up the stumps and load them on the cars as a part of the earth excavation. Should the engineer and contractor have a disagreement, and the engineer wish to put the "screws" on the contractor, such a clause affords him opportunity. Under it he can order the contractor to grub the ground before the steam shovel goes to work.

In like manner advantage can be taken of the contractor in rock cuts. Instead of waiting to blast the stumps out as the rock is excavated, the grubbing not

only of stumps but also of roots can be ordered done by the engineer prior to the rock blasting.

"The surface of the ground to be excavated" will be made free from stumps and roots, no matter whether anything is said about it in the specifications or not, for the contractor can not escape doing so. This being so, it is superfluous to specify clearing, grubbing between the slope stakes, unless it is the intention to remove all vegetable matter from the materials that are to be used in making embankments. On railroad work it is not customary to remove sod or small roots from embankments or from the surface of ground to be covered by embankments, yet, under the strict letter of this specification a contractor can be compelled to do both.

It may be replied that no reasonable engineer would attempt to enforce the letter of this specification, but if a specification serves any useful purpose it is to *specify*, leaving nothing in doubt, nothing dependent upon the "reasonableness" of any one. In matters of this kind it is just as easy to be specific as it is to be vague, and far more satisfactory to all concerned, since all chance for quibble is removed.

Another point that is not always covered definitely is the matter of payment for grubbing. Where steam shovels are used it is becoming the custom not to pay for grubbing; but, unless the specification distinctly states that grubbing will not be paid for in steam shovel cuts, it is probable that a contractor could collect payment.

Ambiguous specifications of the sort under discussion foment trouble sooner or later, and cause some one an unexpected loss not merely of temper but of money.

Methods of paying for grubbing and clearing. The following is taken from a discussion by the author in the construction news supplement of *Engineering News*, Jan. 14, 1904: There are, in common use, three methods of paying for grubbing and clearing: (1) By the acre; (2) by the lump sum; and (3) by inclusion within the price paid per cubic yard for excavation. The lump sum method is perhaps to be preferred where the area to be cleared is comparatively small and where no material

changes in location of work are probable. Thus the clearing of a small reservoir site, whose location is definitely fixed, may well be paid for by the lump sum. Similarly in road improvement (not through a new country), either method (2) or method (3) may be used.

Where the clearing forms a very considerable item, however, and especially where the alinement or the grade of a road, railroad or canal, is likely to be changed after awarding the contract, payment by the acre should be specified. To do so, in the first place, gives a basis upon which the engineer can make his monthly estimates, without any chance for serious dispute as to equitable partial payments. But what is perhaps of greater importance is the fact that any increase or decrease in the area cleared is provided for where a unit price exists. Moreover, to call for bids on clearing and grubbing by the acre gives the engineer definite information as to what contractors have found such work to cost, and thus enables closer estimates of similar work in the future. Where the grubbing and clearing is included in the price bid for the earthwork, it is evident that earth taken from shallow cuts, well covered with brush and trees, will be bid in at what appears to be an abnormally high price; while on the other hand, if the cuts are deep the price per cubic yard will be much lower, since the total cost of grubbing and clearing distributed over a large yardage makes a very small additional cost per yard. If after the award of a road contract the grade line is raised or lowered for a long distance, and the yardage materially changed the contractor will have a just claim for a change in his unit price in earth where clearing and grubbing is included in the price paid for cut or fill.

In our last week's issue a correspondent raised a question that has caused disputes before and will cause disputes again, unless the standard wording of clearing and grubbing clauses be modified. The clause in question reads:

Clearing and grubbing shall be paid for by the acre of actual area cleared.

Evidently such a clause makes no provision for single

trees. Not long ago a specification was sent to this office in which provision was made for this contingency, by specifying the exact amount that would be paid for removing single trees.

The clause reads:

| | |
|-------------------------------------|-------------|
| For Removing Trees: | |
| 6 ins. or less in diameter | \$1.50 each |
| 6 ins. to 12 ins. in diameter | 3.00 each |
| 12 ins. and over in diameter | 5.00 each |

There are, of course, large trees whose removal costs much more than \$5 each, and where many such trees occur the sliding scale of prices should be extended.

While discussing the subject of grubbing and clearing, we may go a step farther and point out the desirability in many cases of having two separate items, one of clearing, and the other of grubbing, to be paid for separately. Where stumps are to be covered with a railroad embankment of any considerable height, it is usually sufficient to close-cut them, and do no grubbing at all. But, of course, where excavation is to be made, the stumps must be taken out. On steam shovel work the stumps are not ordinarily grubbed out by hand or with powder, but are removed by the steam shovel as they are encountered. But on scraper work, stumps, and brush roots especially, are so great a hindrance to rapid work that their prior removal is an economic necessity. Often the removal of brush roots adds several cents per cubic yard to the cost of excavation.

Enough has been said to indicate the desirability of specifying payment by the acre for clearing, and by the acre for grubbing, rather than by any other method on extensive work; and provision should be made in the specifications to cover the cost of single tree removal. Very often, however, specifications are not very clear as to how much or how large brush shall be, to constitute clearing and grubbing. A little study of the local conditions will enable the engineer to designate clearly what he intends to include or exclude, and in some cases it is well to mark on the plans the areas that are included as clearing and grubbing areas.

Custom as to payment for clearing and grubbing. (From a letter published in *Engineering News*, Jan. 14, 1904). The clearing and grubbing should not be combined. The area cleared is seldom the same as that grubbed. The specifications generally confine the grubbing to excavations and under embankments of less than 2 ft. depth. Grubbing for borrow pits on right of way is at the contractor's expense. It is one of those things that is put in to get something for nothing, viz., the railway company expects the price of clearing to be no higher if the grubbing is included.

It has been a custom to estimate full clearing when the branches of trees touch; and if there are isolated trees the area covered by vertical lines from tips of branches is generally a fair measure of ground cleared, and with the "combined" specification it also pays for the grubbing. With the small tree, the area covered being less, it equalizes the smaller expense of removing the stump.

What constitutes an acre of actual area cleared. Mr. Thos. H. Mather, in a letter published in *Engineering News*, Jan. 14, 1904, makes the following statements: Under the specification that "grubbing and clearing shall be paid for by the acre of the actual area cleared," any timber growing in such contiguity as in a grove, orchard or woods, irrespective of how close the timber was standing, if only the line and limits of the growth were well defined, should be classed as clearing.

Second, the area allowed for an isolated tree should depend on the size of the tree and what in the Engineer's opinion would be a fair price for its removal. I should take the circumstances into consideration and give such an area in isolated trees as the facts warranted. For instance, if an isolated tree, in my opinion, cost \$10 to remove, and the price for clearing was \$100 per acre, I should allow one-tenth of an acre; if another isolated tree cost 15 cts. to remove I should take no notice of it. If in continuous woods the contractor lost or made money on the clearing I should feel that he was working under the specification pure and simple, and that I had no option but to give him the area within the defined lines

An interesting legal decision relating to clearing and grubbing is reported to *Engineering News*, Jan. 14, 1904, by Mr. Woolsey Finnell. The following is an abstract of his letter: On resuming construction of the Montgomery Division of the M. & O. R. R. between Tuscaloosa and Montgomery, Ala., in 1897, a dispute arose between the sub-contractor and contractor regarding what constituted a station of clearing and grubbing. The right of way for that part of the railroad had been cleared and 75% of the grading had been completed in 1890 and 1891. During the intervening six years the right of way had grown up in briars, vines and brush which together with a few isolated tree stumps and logs on the uncompleted sections of the road constituted the clearing. The contractor who was completing the road for a lump sum gave the sub-contractor estimates of from $\frac{1}{5}$ to $\frac{1}{3}$ clearing for the work done on the previously completed sub-grade. The sub-contractor brought suit for "full clearing" obtaining a favorable decision. The following is an abstract of the decision of the court: "The court holds that where any clearing has to be done on any station (of 100 ft.), it shall be estimated as clearing, and the court further holds that the size or number of trees, bushes, briars, etc., cut from any station does not have any bearing on the case, the specifications setting forth that clearing and grubbing shall be paid for when it is actually done." The court also ruled that 100 ft. should be used as a basis of measurement because it was proved by all the witnesses, both for the plaintiffs and the defense, that 100 ft. was the customary unit used in estimating clearing. The court rendered its verdict in favor of the plaintiffs and ordered estimates made accordingly.

Although this case involved more than \$23,000 no appeal was taken and the award of the court was promptly paid.

Road specifications. Frye, in his Civil Engineers' Pocketbook, quotes the following from Road Specifications used in Alleghany County, Pa.: *Clearing.* Trees, stumps, bushes, roots, etc., to be removed and no perishable matter allowed under embankments.

Instructions for Preliminary Work issued by the Department of the State Engineer, New York 1903, gives the following:

Clearing. The item of clearing shall include the removal of all trees, bushes, stumps, decayed or growing vegetable matter above the surface of the ground.

Grubbing. The item of grubbing will include the removal of all vegetable matter below the surface of the ground over areas upon which embankments are to be built. Grubbing will only be estimated on areas on which embankment or backfill is to be placed.

Better highway specifications for clearing and grubbing. The following, by F. W. Harris, is taken from *Engineering News*, Dec. 23, 1915:

The following clauses are the usual highway specification for grubbing:

All stumps, roots, logs and other obstructions shall be grubbed out and removed from all places where embankments occur less than 3 feet in height; also where excavations occur less than 3 feet in depth, and from such other places as the engineer may direct.

All material so grubbed out shall be destroyed in the manner specified.

Grubbing shall be paid for by the acre or fraction of an acre. The area within the limits of the slope stakes, whenever grubbing shall have been done thereon by the contractor, shall be estimated only upon cuts up to 3 feet in depth, and under embankments of 3 feet or less in height, and upon uniform ditches wherever the engineer may direct.

This is the old railroad specification. It answered the railroad purpose well enough, for grubbing is but a detail in that class of work, owing to the heavy cuts and fills and the much narrower width of roadbed. It is only with the wide roadways and "scratch work" of roadbuilding that grubbing comes to the front as an important factor.

Grubbing has been estimated and paid for in at least four different ways—by lump sum, station, acreage, and square rod. All these methods are founded on approximate estimates. The lump sum was the easiest way adopted on small jobs where the contractor was in a position to make a fairly close estimate. Grubbing by

the station was one way of payment used by the railroads where the cut and fill was under 3 ft. By the present system grubbing is paid for by the acre or fraction thereof.

Such a clause as the above has been interpreted in two different ways: One way is shown in Fig. 4 as *X*, which gives a measurement of 14 ft. This method is close and very unfair. Others use a full width between the slope stakes, shown as *Y*. This gives a measurement of 42 ft., which is more fair and liberal for the following reason: Frequently there is a stump on the slope line (stump *A*) which the engineer wants removed for the sake of appearance. The same reason will apply for grubbing out the stump *C*. Also in both cases the stumps are within the 3-ft. limit. Even using the *Y* method of computing acreage, in nine cases out of ten the grubbing will be done at a loss to the contractor.

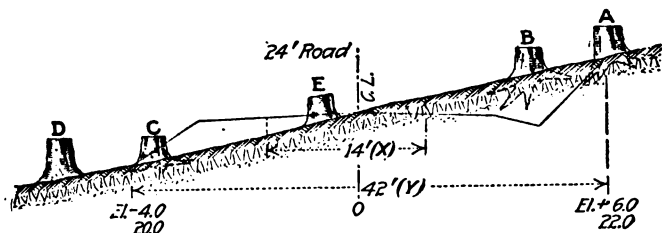

Fig. 4. Road Cross-Section Showing How Grubbing Specifications May Be Interpreted

The present system of estimating the cost of grubbing for highways results in almost endless confusion and wild guessing, both on the part of the engineer in his estimate and the contractor in bidding. On one large highway contract involving the construction of 25 mi. of mountain road, bids on grubbing ranged from \$100 to \$300 per acre. The \$100 man did not have the least idea of what he was doing. The \$300 man figured a profit on the grubbing. In this case \$200 was about right, as the grubbing was heavy and in addition to this there was a long and expensive haul to get powder.

The acreage of grubbing in the present estimates of

quantity shows only the amount of grubbing that comes within the specification, and not what the contractor will actually be required to do. The engineer does not know the actual amount that the contractor will have to do; neither does the contractor, hence we have wildcat bidding on grubbing and no cost data on the subject that are worth a moment's consideration.

To remedy this condition the contractor should receive payment for every stump removed, regardless of the depth of cut or height of fill. He is entitled to be paid for grubbing stump *B*, as much as for grubbing stump *E*. The idea that stump *B* will cave in with the excavation is a fallacy, as this course is never adopted on construction work, for when a contractor is organized to shovel earth he does not want to break into the scheme to handle stumps.

The system of paying for grubbing by acreage must be abandoned and the stumps graded according to size. A convenient and practicable grading of sizes runs from 6 to 12 in., 12 to 24 in., 24 to 36 in., and above 36 in. No grubbing should be paid for on anything smaller than 6 in. Stumps from 6 to 24 in. should be measured 4 ft. from the ground. Stumps over 24 in. should be measured at the butt log. It would be impossible to measure large redwood, cypress and cedar stumps "breast high."

In the schedule of quantities submitted to contractors the stumps would be listed like the following:

100— 6 to 12 in.
125—12 to 24 in.

150—24 to 36 in.
200—above 36 in.

The contractor would then know just exactly what he has to bid on and what he has to move. He will be paid for every stump handled. It would be but a short time before grubbing would be standardized in price according to different localities, which would result in closer estimates of final cost.

There is another feature of grading stumps which makes it a valuable aid in making preliminary estimates, especially for those to be let on a lump-sum basis. The majority of engineers refuse to allow waste in any quantity to show on the profiles. This results in too close

a theoretical balance, as the percentage of shrinkage is nearly always underestimated. Consequently the excavations will not make the embankments. A sag has to be put in the fill, or if earth is borrowed there is a bill of "extras" which makes the lump-sum bid almost useless.

Reservoir and dam specifications. Merriman, in the "American Civil Engineers' Pocketbook," gives the following on clearing reservoir sites:

Soil Stripping. In order to prevent the growths of algæ reservoir sites are sometimes cleaned by removing the vegetation and top soil. This practise has been followed extensively in Massachusetts reservoirs. It results in a temporary benefit, but ultimately deposits of material occur on the bottom that contain as much organic matter as that found in the soil, and the advantage of stripping it lost. The organic matter that has the greatest effect on the quality of impounding waters is derived from grass, weeds and other vegetation on the reservoir site. This should be removed by cutting and burning just before the reservoir is filled. For the sake of appearance and to prevent growths of water weeds and filamentous algæ the shores of the reservoir from 2 to 5 ft. vertically above the high-water mark and for 10 to 20 ft. below, according to circumstances, should be cleared of stumps and roots. Elsewhere the stumps should be cut to 12 in. or less above the mean surface of the ground.

Specifications for Hudson water works. (H. K. Bishop, Ch. Engr., and C. C. Vermeule, Consult. Eng.)

Grubbing and Clearing. The contractor will be required to grub and clear the entire surface of the reservoir to a level of 4 ft. above the flow line of all trees, stumps, brush, fencing, and rubbish, and he shall cut all grass or other vegetable matter close to the ground.

Specifications for construction of, subsiding and coagulating basins. Richmond, Va., 1903.

Excavation. The work to be done consists of all the clearing, grubbing and removal of every description over the site of the work. All such rubbish shall be removed entirely from the location of the proposed work. The

contractor, along the site of the proposed embankments, shall remove the loam or sandy soil to such depth as the Superintendent may direct before commencing.

Specifications for municipal water works system for the Village of Poland, N. Y. (W. G. Stone & Son, Engrs.)

Specification for dam. This dam will be constructed of earth with clay core wall as shown on plans. In beginning construction the contractor will thoroughly grub and clear such portion of the original ravine banks as will be covered by the dam, removing all sod, tree roots, stumps, stones, etc., and thoroughly break up the surface by plowing or otherwise so that the dam material as deposited therein will thoroughly mix and blend with the original earth.

Clearing and grubbing specifications, Bartlesville Water Co., 1904. The work to be done under this heading contemplates the clearing and removal of all trees, bushes, shrubs and debris of every nature, from that portion of the site included lying and situated on the west bank of Caney Creek, 260 x 300 ft. in size. Stakes set by the engineer will show the limits of said tract. All trees felled must be taken down in such a manner that no stumps shall be left and so no portion of the tree shall protrude for more than six inches above the natural surface of the ground.

All brush must be burned and the bodies of all trees must be cut in lengths not to exceed 13 ft. and piled as the engineer may direct.

That space of ground to be covered by the reservoirs, pump pit and pump house must be prepared as follows:

By removal of all stumps, roots and vegetable growth, by the removal down to an acceptable hard clay bottom of all material found thereon. The material removed must be wasted below the plant site at a place designated by the engineer.

Specifications for an earth dam built at McAlester, Okla., in 1912.

Clearing and grubbing. The entire surface covered by the earthen embankment and spillway shall be cleared of all trees, brush and shrubs, and all these shall be

grubbed out not less than 2 ft. below the surface of the ground and in a manner satisfactory to the engineer. All rock shall be removed to such depth as the engineer may direct, and deposited at a place designated by him.

Stripping. The area to be covered by the embankment shall be stripped by plowing and scraping, to a depth of 6 ins., and the soil, when suitable, stacked at some convenient point below the dam, to be later used as directed by the engineer.

Dam embankment. The first step in building the dam embankment will be to thoroughly fill all holes made by stump grubbing, rock blasting, etc., with puddled clay, well wetted, mixed and tamped into place, up to the level of the stripped surface. And by the removal of all loose material, rock, etc., found in the water courses of the creek, down to an acceptable hard clay or rock foundation, and within such limits beyond the extreme lines of the embankment as the engineer may direct; and by filling said water courses with suitable material, satisfactory to the engineer, in layers not to exceed 10 ins., solidly compacted by tamping up to the level of the stripped surface.

After the stump holes have been puddled full, the embankment proper shall be begun by plowing up the stripped surface in furrows 6 ins. deep, spaced not more than 24 ins. Upon the surface thus plowed shall be placed earth taken from the valley and hillsides as directed by the engineer, and not nearer than 100 ft. from the toe of the slope of the dam, in a first horizontal layer not to exceed 9 ins. in loose thickness. This shall be thoroughly wetted and rolled with a grooved roller (approved by the engineer) capable of giving a compression of 125 lbs. per lin. in. of roller face.

The earthy materials used in the construction of the embankment shall be free from roots, sticks and stones of size that might be injurious to the structure, and shall in every detail be subject to the approval or the rejection of the engineer. A sufficient quantity of the surface earth from the borrow pits shall be deposited at such places as the engineer may direct for the purpose of top-

dressing the top of the dam and the outer and inner slopes.

Specifications from Contract No. 3, Board of Water Supply of City of New York, for building the main dams for the Ashokan Reservoir. Clearing. Item 37. The sites of embankments and such adjoining areas as directed shall be cleared of all buildings and fences, and all trees, bushes, logs, stumps, high grass, weeds and rubbish. These materials shall be burned or otherwise disposed of as directed.

Wood and hay may be cut by the contractor on designated areas and wood and hay so cut shall be his property.

All trees on the sites of the Dam and the dikes, within the lines of the structures, shall be cut and the stumps entirely removed. Roots, 1 inch or more in diameter, shall be grubbed as directed.

The areas to be paid for shall be those from which all incumbrances as herein provided shall have been removed as ordered. Payment will be made but once for any given area regardless of how many times it may be found necessary to go over the area in order to leave it at the completion of this contract in a condition in accordance with the specifications. The price stipulated in Item 37 shall include the cost of clearing the areas of all incumbrances, the disposing of all materials, and all expenses incidental thereto.

Other specifications. Mr. W. D. Taylor, in *Engineering News*, April 7, 1904, gives the following: The price bid for clearing on this line will be understood to apply only to the densest, heaviest and most extensive clearing on the line. All clearing requiring less work and expense shall be rated by the engineer. Thus if in the judgment of the engineer the work and expense necessary to clear a certain acre of right of way is only one-quarter as much as that necessary to clear one acre of the densest and heaviest timber then that certain acre shall be entered on the contractor's clearing account as $\frac{1}{4}$ of an acre.

E. H. Beckler, in commenting on above, submits the following:

Clearing will be done to the full width of the right of way and will be estimated by the station. A station consists of 100 ft. in length by 100 ft. in width. Extra width will be equated into stations as above defined.

Clearing will include the removal of all perennial plants, not including briars. Any cutting within the limits of the station stakes constitutes a station of clearing.

Clearing and grubbing clauses under railroad grading in Civil Engineering Specifications and Contracts by Ashbridge. *Clearing.* The lands of the railroad company shall be cleared to the full extent of the right of way of all trees, logs, bushes, and other perishable matter, which shall be destroyed by burning or deposited in heaps as the engineers may direct. Large trees must be cut not more than 1 ft. from the ground and under embankments less than 4 ft. high. They shall be cut even with the ground. The top of stumps shall not be less than 3 ft. below sub-grade under embankments. All small trees and bushes shall be cut even with the ground. The burning of brush must be done in such a manner as not to endanger adjacent timber, land or property. Clearing shall be paid for by the acre or fraction thereof to the extent indicated by the engineer by stakes or by marks on the ground or timber. All trees which the engineer may reserve shall be stripped of their tops and branches cut to such lengths and be neatly piled at such places as the engineer may direct.

Grubbing. All stumps, roots, muck and perishable material shall be grubbed out and removed from all places where embankments occur less than 2 ft. in height. All stumps grubbed out shall be burned. Until the contractor is notified that the work done on the surface to be grubbed is satisfactory to the engineer, no embankment shall be made on such surface. Grubbing is to be paid for by the acre or fraction thereof actually grubbed.

American Railway Engineering Association Manual 1911. *Clearing.* The right of way and stations

grounds except any portion thereof that may be reserved shall be cleared of all trees, brush and perishable materials of whatsoever nature.

All these materials, except as hereinafter mentioned, shall be burned or otherwise removed from the ground, as may be directed, and without injury to adjoining property.

Where clearing is to be done, stumps shall be cut close to the ground not higher than the stump top diameter for twelve (12) inches, and less in diameter and not higher than eighteen (18) inches for trees whose stump top diameter exceeds twelve (12) inches except between slope stakes of embankments where stumps may be cut so that the depths of filling over them shall not be less than two and one-half ($2\frac{1}{2}$) ft.

The work of clearing shall be kept at least one thousand (1000) ft. in advance of grading.

All trees which may be reserved shall be stripped of their tops and branches made into ties, or cut to such lengths as may be directed and neatly piled at such places on the right of way as may be designated, for which service payment shall be made by the tie or by the cord of one hundred and twenty-eight (128) cu. ft.

In localities where isolated trees and buildings exist payment shall be made for their removal at a price to be agreed upon.

Measurement of clearing and payment for the same shall be by units of one hundred (100) ft. square or a fraction thereof actually cleared.

Grubbing. Stumps shall be grubbed entirely from all places where excavations occur, including ground from which material is to be borrowed, as well as from ditches, new channels for waterways and other places where required.

Grubbing shall also be required between the slope stakes of all embankments of less than two and one-half ($2\frac{1}{2}$) ft. in height.

The work of grubbing shall be kept at least three hundred (300) ft. in advance of grading.

Measurement of grubbing shall be measured upon all excavation actually done, and the space to be covered by all embankments of less than two and one-half ($2\frac{1}{2}$) ft. in height. Payment for the same shall be by units of one hundred (100) ft. square or fraction thereof actually grubbed.

CHAPTER III

CLEARING

Land clearing practice. The following is given by Mr. M. J. Thompson in Bulletin 163 of the University of Minnesota Agricultural Experiment Station: The tools commonly used are the ax, the brush scythe or brush hook, and the cross-cut saw. Care must be taken in selecting an ax for brushing work. A wide blade is preferable as the wear comes mostly at the two extremes with very little at the center. The ax must be ground to meet this condition and finally a rounded edge results, giving much less cutting surface, and thus limiting the efficiency of the operator. The weight should be not less than $3\frac{1}{4}$ lbs.

In the first brushing of the land the ax is usually a much better tool to use than the scythe. The brush must be cut close to the ground in order to simplify the work of keeping it down in later years. Care should be taken to avoid leaving sharp snags. Low, blunt snags make seeding easier and are easier for the horses' feet. The ax is the better tool with which to secure these results, though not always so rapid as the scythe. This can be used to advantage on the second growth.

It is generally believed that the best time to cut brush is in the late summer or early fall, as at that time the sap is not yet started in the root system for winter storage and the plant can be killed more easily. August is the month usually recommended, although good results were obtained in September and even as late as October. It is advantageous to cut before the leaves fall, as they facilitate burning.

Different plans are followed in burning brush. Many advocate burning when the brush is cut. A fire is started and the brush is thrown on it as rapidly as it is cut. Others recommend cutting and leaving in pile

of about an armful, and later burning in a central pile. When land was logged immediately following brushing, the following plan was found the most advantageous and economical. The brush was carefully piled so that all lay the same way. It was left to settle and dry somewhat before the logging slashings were available and both were burned at the same time. The care, or lack of it, exercised in piling the brush is an important factor in determining the final cost of the work. Disposing of



Fig. 5. Double Bit Axes Made by Collins and Co., Hartford, Conn.; Weights 3 to 6 lbs.

the dead-and-down material and windfalls is often a problem, as they are usually wet. That which would readily be handled was burned first and the rest was sawed into proper lengths for a team to handle and later piled as a base for burning stumps.

The height at which trees should be cut is debatable. As the wood left in stumps is wasted, the trees should be cut off as low as possible. On the other hand, the taller stump is more easily removed by team or puller. This is a matter of prime importance where a stump-puller is used, and considerably less so if dynamite is used.

Stumps are burned in different ways. Where dynamite has been used to good effect, and the stumps are well shattered and thrown out of the ground, they are sometimes left until they are thoroughly dry. Fires are

then started and the pieces are gathered together and thrown on the fire as rapidly as they are collected. However, this presupposes a good job of blasting, all the parts loose if not removed.

Types of axes. Fig. 5 gives a good illustration of the difference in chopping edges of axes.

The ax shown to the left of the cut is known as the Yankee pattern; its short rounded edge makes it suit-



Fig. 6. Single-Bit Chopping Axes Made by Collins and Co., Hartford, Conn.; Weights, 2 to 7 lbs.

able for splitting, but not for chopping. The California Reversible Ax in the center and the Michigan Ax on the right have larger cutting edges and are more suitable for chopping. The Michigan ax, because of the rounded cutting edge on the side toward the handle, is specially adapted to lopping branches from fallen trees where many blows are struck under handed. Fig. 6 shows two single-bit axes which are well shaped for chopping.

Machetes and brush hooks. In tropical America the machete is universally used for all kinds of cutting. It is a long knife sharp enough to be used in cutting grass

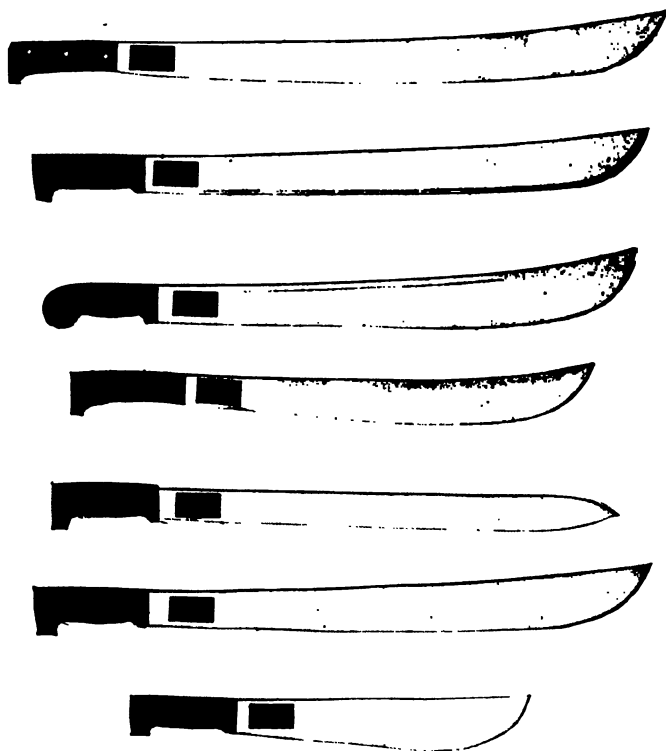

Fig. 7. Machetes Made by Collins and Co., Hartford, Conn.;
Lengths from 10 in. to 28 in. Available

and other fodder and heavy enough for cutting trees up to 6 or 8 ins. in diameter. It is an admirable tool for clearing away vines, brush and saplings and where thorny vines, cactus, or briars are to be cut it is by far the best tool known.

Fig. 8 shows various types of brush hooks. These are handled and used like an ax, but are only suitable for cutting small trees, saplings and vines. They are of little use in clearing away briars.



Fig. 8. Various Types of Brush Hooks

Methods and costs of clearing in Minnesota. Bulletin 163 of the University of Minnesota Agricultural Experiment Station, by M. J. Thompson, gives some valuable data on methods and costs of preparing cut-over timber lands for farming purposes, as follows:

Fifteen acres of cut-over timber land were divided into three tracts of five acres each. On Tract I the clearing was forced with dynamite. On Tract II the stumps were first split with small charges of dynamite and then pulled with a machine. Tract III, after being brushed out, was seeded to clover and timothy for pasturage, and clearing with dynamite was postponed five years, until 1918. Although the work on Tract III is not completed, the general results are of such a nature as to warrant publication for the benefit of those who may be wrestling with the clearing problem.

The conclusions thus far arrived at may be stated tersely as follows:

1. Cost and method are determined largely by the character of the soil and the kind of vegetation.

2. The returns in forest products, cordwood, pole wood, fence posts, and saw logs cover the cost of brushing and other clearing work up to the stumping stage.

3. The cost per stump for blasting and pulling on Tract II was almost identical with the cost of explosives alone on Tract I.

4. The cost of clearing was much less on Tract I, since much less labor was required in piling and burning the stumps.

5. The cost per stump for removal was least for the man-power machine, slightly greater for the horse-power machine, and greatest for dynamite. (This was for green timber and did not include the cost of piling, which makes the use of dynamite the cheapest method by a good margin.)

6. Some relation may apparently be established between the size of the stump and the size of the charge required to remove it.

7. The man-power puller has a limited field where the conditions correspond to those at the Northeast Station. It works to best advantage on the small new farm where the farmer has very limited means.

8. Although the work is still incomplete, it is evident that, under conditions existing on the average farm in the region of the Station, dynamite is usually to be preferred to the stump-puller, either alone or in combination. However, the plan of clearing being followed on Tract III will not only be carried out at a lower cost as predicted, but is actually giving a larger net return in pasturage the first year than has been realized from the first crops from land on which the clearing has been forced. This is because forced clearing requires more labor, and because land cleared by this method is relatively lacking in humus, which curtails yields.

9. The method depends on conditions. There is no one best method for all conditions.

10. Following the removal of stumps from cut-over timber lands, on account of the shallow covering of vegetable matter, care should be taken to plow shallow

the first time and to take immediate steps to increase the humus by seeding the land to clover and grasses, using barley or oats for a nurse crop.

The work from which these deductions were made was done on land which averaged more than 200 stumps to the acre. These had a diameter of about 12 inches at the base and 10 inches at the cut-off. Sixty per cent of the timber was green. The soil is a somewhat stony clay loam with a clay subsoil, generally reddish but in some places bluish gray. The timber was about 57 per cent balsam, 16 per cent birch, 13 per cent pine, 6 per cent cedar, 3 per cent tamarack, 1 per cent spruce, 1 per cent balm of Gilead, and 3 per cent miscellaneous. The lower grades of dynamite were used on all kinds of stumps except green birch, for which 60 per cent was found most efficient.

The experiments which have led to the conclusions mentioned, for further description may be classed as follows:

Cost of clearing expressed in units of time and in units of money.

Detailed study of the various stages of the clearing work.

Forest products, a credit in cost of clearing work.

Relative cost and efficiency of dynamite alone and in combination with a puller.

Individual stump studies.

Standardization of charge, based on size, kind, condition, and location of stump.

Comparative study of dynamites of various strengths.

Special study of the man-power puller.

Land-clearing practice.

Farm development.

Summary.

Preliminary operations. The clearing processes were: (1) brushing, (2) logging, (3) burning, (4) assembling (a) poles, (b) fence posts, (c) cordwood, (d) logs. This work may be called Removal of Overburden, or Stripping, to distinguish it from the work of removing stumps. Any growth under three inches in diameter was considered brush. The first work on each of the

5-acre tracts was to cut the brush and to pile it and the dead-and-down material which was of such a size that it could be readily handled. The trees were then felled across the brush piles, trimmed, and topped. The trees were so felled in order to save labor in handling the tops. When the logs had been trimmed, they were rolled back, and the small material was ready for burning.

The timber was disposed of as follows: All cedars were cut into fence posts. All material sound and straight and not less than 10 ft. long or 6 ins. in diameter at the smaller end was saved for lumber. The small sizes were cut into poles and cordwood, and larger sizes unfit for lumber were similarly disposed of.

The burning followed the logging, as the weather had been favorable and the brush was well piled and cut before all the leaves had fallen. Dry, sunny afternoons were selected for this work whenever possible in order to facilitate the burning. With one man directing a crew of eight, it was possible to burn over 5 acres in half a day.

The careful organization of the crew is very essential to efficient work. The men were deployed along the side of the tract opposite to that from which the wind came. After lighting one row of piles they could fall back and light the second and succeeding rows without being troubled by the smoke. After crossing the tract once, the first fires had burned down so that they could repeat the work, repile, and make a clean burn.

TABLE III
CLEARING COSTS AND TIME REQUIRED PER ACRE TO STUMP-
REMOVAL STAGE *

| Operation | Tract I | | Tract II | | Tract III | | Average time | | Average cost per acre |
|---------------|---------|-------|----------|-------|-----------|-------|--------------|-------|--------------------------------|
| | Man | Horse | Man | Horse | Man | Horse | Man | Horse | |
| | Hours | Hours | Hours | Hours | Hours | Hours | Hours | Hours | |
| Brushing ... | 75.0 | ... | 67.22 | | 47.6 | ... | 63.27 | | \$12.88 |
| Logging | 84.6 | ... | 66.85 | | 90.0 | ... | 80.48 | | 15.40 |
| Burning brush | 8.8 | ... | 11.4 | | 9.45 | ... | 9.88 | | 2.05 |

* Price of man labor 20 cents per hour and of horse labor, 7½ cents per hour. The latter is apparently low. However, at this Station, as at many northern farms in process of development, horses work practically the entire year, thus materially reducing the cost per unit.

CLEARING

| Operation | Tract I | | Tract II | | Tract III | | Average time | | Aver'ge cost per acre |
|-------------------------------|---------|-------|----------|-------|-----------|-------|--------------|-------|-----------------------|
| | Man | Horse | Man | Horse | Man | Horse | Man | Horse | |
| | Hours | Hours | Hours | Hours | Hours | Hours | Hours | Hours | |
| Assembling timber | 17.65 | 18.1 | 17.7 | 17.6 | 24.6 | 26.4 | 19.9 | 20.7 | 5.52 |
| Splitting cord-wood | 7.6 | ... | 7.7 | | 7.5 | ... | 7.6 | | 1.52 |
| Piling cord-wood | 2.5 | 5.0 | 5.7 | 8.0 | 6.0 | 6.0 | 5.0 | 6.3 | 1.47 |
| Cutting pole wood | 18.0 | 17.9 | 17.9 | | 29.0 | ... | 21.63 | | 4.32 |
| Skidding logs | 2.6 | 5.2 | 4.85 | 5.45 | 6.2 | 6.2 | 4.5 | 5.6 | 1.32 |
| Piling logs . . . | 3.25 | 4.1 | 7.2 | 5.3 | 8.0 | 5.2 | 6.4 | 4.86 | 1.64 |
| Total . . . | 220.0 | 32.4 | 207.52 | 36.35 | 228.35 | 43.8 | 218.67 | 37.46 | \$46.53 |

It will be seen that there is some variation in the time spent in brushing. This is partly due to adverse conditions in various places, but on the whole it is fairly uniform, and illustrates what practice will do in making a man or a crew more efficient. The same crew that began the job finished it. The last acre, a difficult one, required but two-thirds the time of the first one. Later work has confirmed these figures. Where all windfalls are included and the small persistent vegetation, such as ground hemlock, is also cut off, the figures will run nearly one-third higher. The removal of windfalls is included elsewhere in this tabulation. The cutting off of small vegetation may be ignored where the land is to be worked and seeded. The cost of logging varied, as there was a difference in the amount of timber to be handled and the stumps were closer together, impeding the work. Best results were secured in burning over the first tract, since it contained less alder and more balsam than was found elsewhere. It was also cut earlier, piled more carefully, and had better drying weather. While immediate burning is often good practice, a delay to allow slashings to dry is more economical in the end.

TABLE IV
FOREST PRODUCTS RECOVERED

| Product | Value per acre |
|---|----------------|
| 2.05 cords hardwood at \$3.75 | \$ 7.68 |
| 9.30 cords soft wood at \$2.00 | \$18.60 |
| 1200 ft. B. M. lumber at \$13.75 per M. | \$16.50 |
| 10 fence posts at \$0.075 | \$ 0.75 |
| Total value | \$43.53 |

Hardwood is the birch timber that was not suitable for lumber. The balsam was also disposed of as cordwood. The price given is the farm price. While the wood was delivered by the farm teams, the price received covered the cost of delivery as well as the farm price. The market is close and the roads good. This permitted maximum daily deliveries. The lumber was sold on the farm. After deducting the cost of sawing, the net returns were \$13.75 per thousand feet. Total receipts are exactly \$3 less than the cost of removal. No credit has been given for sawdust, which was used for bedding; or for slabs, which made splendid fuel at a merely nominal cost. At many places there is at present a good market for balsam and other soft evergreens which are used as pulpwood and for boxes and are purchased at more than fuel prices. As a farmer usually delivers his own wood and other products, he would earn the labor allowance therefor. Considering these items, the statement that, in this region, the value of the product will pay for the cost of clearing up to the time of stumping, unless the market is some distance away, is probably justified.

Removing the stumps. To many persons, land clearing means only the removal of the stumps. In reality this is but one step in the process of clearing, yet one of major importance. In this investigation, 15 acres were cut off. As already stated, 5 acres were blasted green, 5 were blasted and pulled with a stump-puller, and 5 were seeded to clover. A comparison of dynamite and the stump-puller as to methods of handling, cost, and efficiency, is presented.

The general practice of handling explosives is discussed elsewhere. In blasting, two men were usually employed. The assistant made the holes and assembled the materials while the blaster determined and placed the charge, and made the notes. The men usually worked from 7 to 11 in the forenoon, and from 1 to 5 in the afternoon, the remaining hour of each half-day being spent in setting off the charges. Sometimes, when *conditions were very favorable*, all the blasting was de-

ferred until afternoon. Usually, this is very hard on the operator.

Where the stump-puller was used, one team, a teamster, and two, sometimes three, operators were engaged. Two men handled the work nicely, the third helping with the cable. As the average diameter of the stumps was barely 12 ins. at the base and as the stumps were split before pulling, in the one case, and completely removed by dynamite in the other, a piler was not needed. When the shattered portions were too large to be handled readily, they were piled by means of the decking chain in the following way: A pile was started, the decking chain thrown across it, a team hitched to one end and the stump attached to the other. One teamster, with a quiet, well-broken team, thus piled nearly 5 acres. The small sections of the stumps helped to make a solid pile, while the use of the chain gave a high, compact mass that burned readily.

Blasting. In making a study of the statistics several things must be constantly kept in mind. The work was done on land that had been cleared of timber less than a year before, except for a small amount of pine previously culled out. This is expensive. The relative degree of expense will be determined when the third tract has been cleared, after time has elapsed to allow the total or partial decay of the stumps and debris. The work was done by the regular farm crew, who had to be trained for the work as it developed.

TABLE V

COMPARATIVE COST PER ACRE OF DYNAMITE USED ALONE AND IN COMBINATION WITH PULLER—GREEN STUMPAGE

| TRACT I | |
|---|---------|
| Item | Cost |
| 30.6 hours blasting labor at 20 cts. | \$ 6.12 |
| Material | 24.00 |
| 13.0 hours piling refuse timber at 20 cts. | 2.60 |
| 26.56 hours pulling and piling stumps at 20 cts. | 5.31 |
| 53.12 team hours pulling and piling stumps at 7½ cts. ... | 3.98 |
| 8.4 hours' labor repiling at 20 cts. | 1.68 |
| 16.8 team hours repiling at 7½ cts. | 1.23 |
| 3.6 hours' labor burning, at 20 cts. | 0.72 |

CLEARING AND GRUBBING

| Item | Cost |
|--|----------------|
| 13.0 hours miscellaneous labor at 20 cts. | 2.60 |
| 6.0 hours miscellaneous team work at 7½ cts. | 0.45 |
| 21.9 hours' labor picking up stone at 20 cts. | 4.38 |
| 36.8 team hours picking up stones | 2.76 |
| Total | \$55.83 |

TRACT II

| | |
|---|----------------|
| 19.35 hours blasting labor at 20 cts. | \$ 3.87 |
| Material | 8.32 |
| 13 hours piling refuse timber at 20 cts. | 2.60 |
| 36 hours' labor pulling stumps at 20 cts. | 7.20 |
| 24 team hours pulling stumps at 7½ cts. | 1.80 |
| 63.2 hours' labor piling stumps at 20 cts. | 12.64 |
| 112.2 team hours piling stumps at 7½ cts. | 8.41 |
| 3.0 hours' labor repiling at 20 cts. | 0.60 |
| 6.0 hours team labor repiling at 7½ cts. | 0.45 |
| 3.6 hours team burning at 20 cts. | 0.72 |
| 31.6 hours miscellaneous labor at 20 cts. | 6.32 |
| 29.0 hours miscellaneous team labor at 7½ cts. | 2.18 |
| 21.9 hours labor picking up stones at 20 cts. | 4.38 |
| 36.8 team hours picking up stone at 7½ cts. | 2.76 |
| Total | \$62.25 |

TABLE VI

COST PER STUMP ON TRACTS I AND II—GREEN STUMPAGE

TRACT I

| | |
|--|----------------|
| Stumps per acre | 214.0 |
| Average diameter, base (inches) | 11.6 |
| Average diameter, cut-off (inches) | 9.3 |
| Average height (inches) | 26.4 |
| Blasting per stump (minutes) | 8.5 |
| Cost of labor | \$0.029 |
| Cost of explosive | \$0.112 |
| Total cost | \$0.141 |

TRACT II

| | |
|--|---------------|
| Stumps per acre | 220.0 |
| Average diameter, base (inches) | 11.6 |
| Average diameter, cut-off (inches) | 9.4 |
| Average height (inches) | 26.4 |
| Blasting per stump (minutes) | 5.2 |
| Cost of labor | \$0.02 |
| Cost of explosive | \$0.04 |
| Total Cost | \$0.06 |

The total time spent in blasting was divided among the total stumps, although the smaller ones were not blasted. Thus the average 2 cts. per stump given is too small.

Note that on the first tract the cost of blasting was greater for both labor and material. The smaller stumps were not pulled on Tract II as it was assumed that they could be pulled and piled without difficulty. This explains the small cost of labor and dynamite. Practically three days were required to remove 210 stumps from one acre of land, 70 per 10-hour day. Fifty stumps per day is the usually accepted unit for this work. In this case, however, the stumps stood very close together, the average size was smaller, and the operator used good judgment in planning his work, so the total was frequently over 90 stumps per day of 10 hrs. On Tract II the cost for labor and material was less than half. This, however, is not a good basis for comparison. The comparison should be made when the stumps are both pulled and piled. The rule followed was to make the charge strong enough to let the stumps and the roots be removed by man and team without difficulty, and with no waste. The data show that the object was attained in nearly 95 per cent of the attempts.

TABLE VII

BLASTING EFFICIENCY—GREEN STUMPAGE

| | |
|--|-----|
| Acreage involved | 2.5 |
| Total number of stumps | 507 |
| Number blasted completely out | 362 |
| Percentage blasted completely out | 71 |
| Number blasted so as to be removed by horses | 112 |
| Percentage blasted so as to be removed by horses | 22 |
| Blow outs, misfires, etc., requiring further attention | 33 |
| Percentage of blow outs, misfires, etc., requiring further attention | 6.5 |

Pulling. Several horse-power machines were used on Tract II, following the blasting. Two horses and three men were employed, one man acting as teamster and the other two operating the machine. Taking a large

green birch as an anchor and a center, stumps were pulled from all directions. From one setting, from 50 to 75 stumps could be handled, but with increasing difficulty, since each pulled stump was an obstruction. As many as 10 stumps were pulled at a single hitch. This included all sizes, and, of course, all did not come at once. The plan followed was to half-hitch around the nearest stump and then extend the cable and attach it to succeeding stumps in the same way. All the power of the machine was then centered on the first stump until it came out or was snapped off. The cable then automatically tightened and the tension passed on to the next stump continuously until the last stump was reached. Plenty of power was available, so much that frequently dead stumps, especially white pine and balsam, were cut through by the cable, leaving the roots undisturbed. The following table illustrates the operation of the stump-puller:

TABLE VIII

TIME PER ACRE FOR PULLING STUMPS—GREEN STUMPAGE

| | |
|---|------|
| Total number of stumps per acre | 220 |
| Total time per acre: | |
| Man labor (hours) | 36 |
| Horse labor (hours) | 24 |
| Actual time required per acre (hours) | 12 |
| Acreage pulled in one day | 0.83 |
| Average number of stumps pulled daily | 183 |
| Time required per stump: | |
| Machine work (minutes) | 3.3 |
| Man labor (minutes) | 9.8 |
| Horse labor (minutes) | 6.5 |

TABLE IX

COST PER ACRE FOR PULLING STUMPS—GREEN STUMPAGE

| | |
|---|-------------|
| Cost of labor per stump: | |
| Man labor | \$0.03 |
| Horse labor | 0.01 |
| Total | 0.04 |
| <i>Cost of blasting per stump, Tract I (Table VI)</i> | <i>0.06</i> |
| <i>Total cost of removal per stump</i> | <i>0.10</i> |

| | |
|------------------------------|--------|
| Cost of piling per stump: | |
| Tract I | \$0.04 |
| Tract II | 0.10 |
| Final cost per stump, piled: | |
| Tract I | 0.18 |
| Tract II | 0.19 |

A stump was removed every 4 minutes. However, since three men were working, this meant about 11 minutes of man labor and 7 of horse labor. Some stumps were used for anchors, others were overlooked, and still others were cut off by the cable, so the daily average did not exceed 175 stumps, or about 17 per hour. It is interesting to note that the average cost for blasting and pulling on Tract II is almost identical with the cost of explosive alone on Tract I. In this case no rental is allowed for the machine. The increased cost of piling, due to the greater bulk of the root system, the larger fragments, and the adhering clay, makes the final cost lower when explosives are used.

The use of a piler would probably have reduced this somewhat, but the overhead charge would be increased, the basis of comparison with dynamite would be affected, and it would violate the spirit of the project, which was to do the work in such a way that the overhead charge in equipment would be limited to the minimum, and to demonstrate what one man and a team could accomplish. As the stumps were split with dynamite in one field and entirely removed in another, and were small in average diameter (12 inches), a piler was not essential.

Piling. The item of piling is limited to Tract II, while that of pulling and piling covers Tract I, since on Tract I pulling and piling constituted a single operation. It is worthy of note that the work on Tract II required about double the time of that on Tract I. This is readily explainable. On Tract I it was largely a matter of picking and piling the fragments of stumps and pulling those portions remaining in the ground. On Tract II the work was somewhat retarded, as more or less clay and dirt adhered to the base of the stumps and owing to the green character of the timber and the

small amount of dynamite used, more labor was required to separate the shattered portions. The dead-and-down material, consisting of the larger pieces of debris too wet to dispose of at the first burning, was cut and piled and used as a base for burning stumps.

Burning. The cost of burning is large or small according to the time selected and the methods employed. By building piles carefully, higher rather than flat, solid rather than open, burning is facilitated and less repiling is necessary. In every case the starting of the fire should be so timed that repiling may be continued until the entire accumulation is burned.

A stump pile should be of good size, solid in construction, and of considerable height. A steady, hot fire, under most conditions, is thus assured. It is equally important that the piles be repiled frequently, while the fire is alive, and thus clean up the job at once. An additional argument in favor of large piles is that they are fewer in number and consequently less damage is done to the surface soil as much of the humus is destroyed wherever a fire is made. The loss of humus is, however, partly compensated for by the deposit of ashes.

Miscellaneous. Such work as picking and burning roots, blasting boulders, and all work that must be done preceding the picking of stones and plowing, is classed as miscellaneous. Stone-picking is the first picking ahead of the plow and includes all visible stones.

Small stones were easily handled, but the large ones required more attention. Horse power was used, not only in getting them out of the ground, but also in loading them on the trucks. Stones that were missed were picked following the plow, but the charge for this work is not included here. This completes the work up to the plowing.

Standardization of charge. Difficulty in blasting is usually caused by making the charge either too large or too small, both of which result in a loss of explosive, although the latter is, of course, the more desirable of the two. While the size and character of the charge can best be determined by the operator, a few fundamental

principles may be followed with profit. The size of the charge and the strength of dynamite to be used will depend on the size, kind, condition, and location of the stump.

TABLE X
SUGGESTED SIZE AND KIND OF CHARGE

| Kind of stump | Ground diameter Inches | Charge |
|--------------------|---------------------------|------------------------------------|
| Balsam, green | Up to 9 | $\frac{1}{2}$ pound of 33 dynamite |
| | 9 to 10 | $\frac{1}{2}$ " 40 " |
| | 10 to 11 | $\frac{3}{4}$ " 33 " |
| | 11 to 12 | 1 " 33 " |
| | 12 to 14 | 1 " 40 " |
| Balsam, dead | Up to 12 | $\frac{1}{2}$ " 40 " |
| Cedar, green | 13 to 14 | 1 " 33 " |
| Cedar, dead | 14 to 18 | $\frac{1}{2}$ " 33 " |
| Birch, green | Up to 12 | 1 " 40 " |
| | 13 to 15 | $1\frac{1}{2}$ " 40 " |
| | 16 to 22 | 2 " 60 " |
| Birch, dead | Up to 17 | 1 " 33 " |
| | 18 to 20 | 1 " 40 " |
| | 21 to 25 | $1\frac{1}{2}$ " 40 " |
| Pine, dead | Up to 17 | 1 " 33 " |
| | 18 to 21 | 1 " 40 " |

In conjunction with this feature of the work, a test was made of the comparative efficiency of different strengths of dynamite, using an equivalent amount of explosive of different strengths on stumps of the same kind, size and condition.

This table is not complete, as, in the land involved, enough stumps of the required size and condition to fit our needs could not be found, balsam excepted. Thus, a birch stump is usually of considerable size, but the number of both green and dead was too limited to secure exact duplicates. Green pine was very scarce. Dead balsam was not available. In each group of two, the charge was placed at the same relative depth. While the depth of the charge varied with the diameter of the stump at the ground line in all cases, no definite scale could be formulated. It has been suggested that the depth should about equal the diameter of the stump at

the base. This will help the beginner, but his good judgment will finally be the best guide. Get the charge deep enough. It is probably better to place a charge too deep than not deep enough.

In blasting the smaller stumps, such as balsam, cedar, tamarack, spruce, pine, and balm of Gilead, the 33 and 40 per cent grades were most effective, considering the cost. In blasting green birch, nothing less than 60 per cent gave satisfaction. Green birch is difficult to handle. With the weaker grades of explosive the strength of the charge was spent on the stump proper, often leaving it

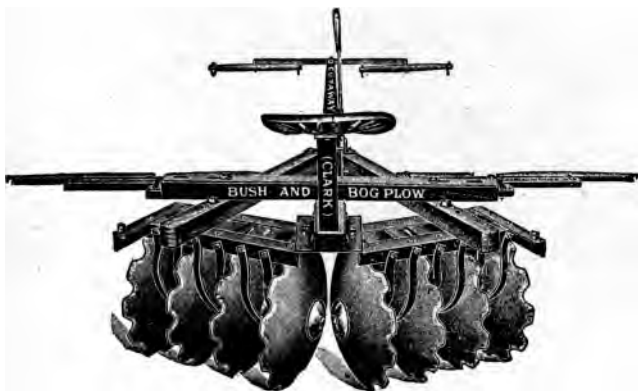

Fig. 9. Cutaway Bush and Bog Plow. Made by the Cutaway Harrow Co., Higganum, Conn. An Efficient Tool on New Land

in worse condition than at first. With the higher grades, a saucer-shaped hole was made, and both roots and stumps proper were loosened and splintered, so that the entire mass could easily be removed. The data secured did not support the idea that using a larger quantity of weaker dynamite is equivalent to a smaller quantity of a richer grade. On the other hand, labor considered, it is probably somewhat more expensive.

Seeding. An admirable tool for bringing newly cleared land (whether the stumps have been removed or not) under cultivation is the cutaway disk harrow. A

special heavy model is made which cuts, chops and breaks the soil going over obstacles which would stop a plow. This has the further advantage over the plow of not bringing roots and trash to the surface but chopping and leaving them in the ground where they will rot and add to the soil. This machine is built with eight 24-in. disks and weighs 680 lbs. Another type with eight 16-in. disks is rigged with shafts for use with one horse. It could be used in seeding down stump land even where the stumps are very thick.

Good results have been secured from the following mixture: 1 pound each of white, alsike, and medium red clover; 2 pounds of timothy; and 2 pounds of bluegrass. On low ground the red clover was omitted and 2 pounds of alsike substituted.

NOTE:—The mixture, given by Mr. Thompson as satisfactory for Minnesota, will probably not be found satisfactory outside of the lake states. Most newly cleared ground is infested with weeds, and unless it has been thoroughly burned over the use of a nurse crop will be advisable.

Crops following clearing. Tract I was cropped to oats and seeded to clover and timothy late in June, the crop being cut for hay. Tract II was cropped to corn but owing to an unfavorable season and late planting no crop was harvested. Tract III was used for pasture. The annual report for 1915 contains the following regarding this tract. Owing to the remote location of this pasture and the expense of getting the stock to and from exact data were recorded for a period of one month only after which the herd was given free range of this field together with the rest of the pasturage area for this 30-day period the net return was as follows:

| | |
|---|---------------|
| Total net return for butter fat per acre per month | \$4.50 |
| Total net return in increased weight of young stock per acre, 18 pounds at 5 cents per pound | 0.90 |
| Total | <u>\$5.40</u> |

Following this period the entire herd was given free

range over this pasture and the rest of the timber lot for a period of ten weeks, granting that the late pasture was poorer this season; (it is usually as good) we may consider a total net return of \$10.00 per acre a conservative estimate for the first year after seeding. Admittedly it will be better in succeeding years.

The foregoing abstract from Bulletin 163 calls attention to the possible loss in humus, which may be brought about through the burning of stumps and of the vegetable soil itself.

In this connection it is well to remember that forest soils are apt to be sour and that as they contain much vegetable matter it may be advisable to sacrifice some of it for the "sweetening" effect of burning. The subsoil may well be the deciding factor. Thus it would be folly to destroy the humus of a thin forest soil overlying a sandy subsoil whereas over clay considerable burning might be beneficial.

Cost of clearing reservoir at Indian River, N. Y. (*Engineering News*, May 18, 1899.) On this work the specifications provided that all timber and brush of every kind should be cut to within 2 or 3 ft. of the ground and thoroughly burned or otherwise disposed of. The total area was 1,160 acres, mostly covered with second growth timber, consisting of small spruce, balsams and various hardwoods. The larger trees were chiefly hardwood which would not float. The trunks of the hardwood trees were trimmed and allowed to lie at the reservoir bottom, while the trunks of the soft wood trees were floated off. All trimmings and brush were burned.

The timber amounted to the equal of 75 cords per acre, or a total of 70,000 cords. The work of clearing was performed by gangs of twenty men, each under a foreman. Laborers received \$1 per day and board, and foremen, \$35 per month and board. The average cost per acre of cutting, including some piling but no burning, was \$7.50. One man cut one-fifth acre per day, including some piling.

Bidding prices for clearing land in Ontario. The following is given by J. Antonisen, in *Engineering and*

Contracting, Mar. 2, 1910: Some weeks ago I called for tenders for the clearing of 20 acres of land at Port Arthur, Ont. The object was to show the suitability of land for factory sites; the bidders were therefore requested to figure on cutting down the smaller trees and the underbrush close to the ground, but were to be allowed to cut the larger trees from 12 to 18 ins. above the ground. All the wood had to be burnt or removed. About 11 acres were covered with tamarack and spruce trees of fairly large size, but very few trees being more than 12 ins. in diameter 18 ins. above ground. Nine acres were covered with close underbrush of alder with a few small birch trees and poplars. The land is situated about two miles from Port Arthur, and there is no summer road to it, but it may be reached in the winter by driving on Lake Superior along the shore.

Nineteen tenders were received with prices ranging from \$15 to \$57 per acre; the lowest bidder failed to enclose a marked check with his tender so that the contract was awarded to the next lowest bidder, who offered to do the work for \$17 per acre. The other bidders submitted the following prices:

| | |
|---------------------|------------------|
| 3 Contractors | \$18.00 per acre |
| 1 Contractor | 19.00 per acre |
| 1 Contractor | 19.50 per acre |
| 4 Contractors | 20.00 per acre |
| 2 Contractors | 24.00 per acre |
| 1 Contractor | 25.00 per acre |
| 1 Contractor | 29.00 per acre |
| 2 Contractors | 30.00 per acre |
| 1 Contractor | 40.00 per acre |
| 1 Contractor | 57.00 per acre |

The highest bidder offered to finish the work on June 15, or in practically four months. He evidently intended to do the work alone and figured to clear one acre every five days.

The wages in our locality are \$2 for ordinary laborers for 10 hrs., and \$2.25 to \$2.50 for good axmen. The tamarack and spruce would make good cordwood, but the other wood is of no value. The sleighing is very

good, and there is little work of any kind being done now, so that laborers are plentiful.

Two years ago I had 70 acres of land cleared in the same vicinity but with a lighter growth of birch and poplar, and I specified that all trees over 4 ins. in diameter should be left standing. This work was done for \$9 per acre.

Clearing and grubbing a dam site in British Columbia. Mr. C. E. Blee gives the following in an account of the construction of the Bear Creek Hydraulic Fill Dam, Jordan River Development, British Columbia, in *Engineering and Contracting*, May 21, 1913: The site of the dam was covered with a very heavy timber growth of fir, cedar, hemlock and spruce. The dam site proper was cleared and all stumps removed, while all timber which could reach the dam or spillway in falling was cut, but not stumped. The borrow-pit area was likewise cleared, and the stumps here were removed as they were reached by the excavation. The flowage area was not cleared, excepting the area immediately adjacent to the dam. Stumps were removed with powder and with donkey engines, and donkey engines were used to some extent in piling logs, etc., for burning. However, as a general rule, it was found more economical to buck-saw the logs into shorter lengths and roll and pile them by hand.

The area within the lines of the dam was stripped to a depth of about 2 ft. to expose the soil proper. In part of the stripping work, and in removing snow, V-shaped flumes were used to good advantage in carrying off the material. Water was diverted from a small tributary creek and carried across the dam site in light flumes, whose position could be readily shifted. The snow and stripped material was then shoveled directly into the flumes and carried off by the water, being discharged below the dam. The clearing and stripping work is summarized as follows:

SUMMARY OF CLEARING AND STRIPPING

| | Acres |
|--|-------|
| <i>Cleared and stumped for dam site</i> | 5.3 |
| <i>Cleared, but not stumped, adjacent to dam</i> | 11.4 |

| | Acres |
|---|-------|
| Cleared, but not stumped, for borrow pits | 9.0 |
| Cleared, but not stumped, for camp site | 3.0 |
| Stripped for dam site | 4.1 |

ITEMIZED LABOR COST CLEARING DAM SITE

| | Per acre |
|---|----------|
| Falling | \$ 38.50 |
| Swamping and burning brush | 127.50 |
| Bucking | 140.50 |
| Log rolling and burning | 260.00 |
| Powder work | 38.50 |
| Donkey work (pulling stumps and piling) | 198.50 |
| Second burning | 60.00 |
| | \$863.50 |

Timber on above was estimated at 100,000 ft. B. M. per acre, including unmerchantable timber. The following prices were paid for labor: Fallers, 40 cts. an hour; buckers, 32½ cts. an hour; swampers and common labor, 27½ cts. an hour. Weather conditions were unfavorable throughout the work, due to rain and snow.

Cost of stripping dam site to average depth of 2 ft., shoveling into V-flumes, \$737 per acre.

Cost of clearing and grubbing, Okanogan Project, Wash. *Engineering and Contracting*, Nov. 5, 1913, in an article comparing the prices bid and actual construction costs on the Okanogan Project, in Washington, U. S. Reclamation Service, gives the following: Price bid for clearing 300 acres of reservoir site, \$75 per acre; actual cost \$29.44 per acre. Price bid for clearing and grubbing 6 acres of dam site, \$150 per acre; actual cost \$168.

Building skid roads and corduroy roads. A "skid road" consists of round poles bedded in the ground like railway cross-ties about 4 ft. apart. These poles or "skids" are usually about 8 to 12 ins. in diameter and 6 or 8 ft. long. With wages at \$2.50 a day the poles can be cut, delivered and laid to form a skid road through a woods at a cost of about \$75 a miles. Large logs can be "skidded" or dragged over such a road. For hauling shingle bolts and cordwood, "skid sleds" are built. These have wooden runners about 10 ft. long. A tea

of horse can pull a heavier load on a "skid sled," or "boat," over well-greased "skids" than it can pull over a dirt road, unless the dirt road is smooth and hard. A "skid road" remains serviceable even in wet weather, when a dirt road may become impassable.

For the cost of building corduroy roads, see my "Handbook of Cost Data."

Making cordwood. A good axman will cut down fir or pine trees and make them into 4-ft. cordwood at the rate of 2 cords per 10-hr. day. An extra good woodsman will make 3 cords a day.

Cost of cutting cordwood. Frequently a contractor must figure on using wood for fuel, in which case it is desirable that he know the cost of cutting and piling cordwood. The following average record relates to work done in the state of Washington under the direction of the author. The work involved the felling of the trees, which were fir, sawing them into cordwood lengths (4 ft.), splitting and piling. Axmen averaged 2 cords per 10-hour day, but an extra good woodsman will readily average 3 cords per day. With wages at \$2.50, a cord of wood cost \$1.25 ready for hauling.

A cord measures 128 cu. ft., of which about 65% is solid wood, the remaining 35% being the voids or spaces between the sticks. Washington fir when green weighs about 3.5 lbs. per ft. B. M., and about 3.2 lbs. when dry. Hence a cord of green fir weighs about 3,200 lbs., or 1.6 tons, which is a good wagon load on most roads. About 10 cords is the ordinary carload.

On a wager, a Vermont woodsman undertook to cut down, chop up, split and pile 5 cords of basswood between sunrise and sunset. He did it, with nearly an hour and a half to spare, for he had completed his work in 10 hours, and had half a cord of unpiled wood left over. The trees ranged in length from 60 to 70 ft. and were 9 to 13 ins. diameter at the butt. At the end of 4 hrs. and 40 mins. he had felled 18 trees and had chopped and split $3\frac{1}{2}$ cords. It took him about 2 hrs. and 40 mins. to pile the 5 cords.

This record is said to be the best ever made. It is

interesting to note that this man's output was about double what is regarded as a good day's work, and, in this respect, the record bears out the generalization that a man can perform on a wager about double the physical work that he is accustomed to do day in and day out.

CHAPTER IV

GRUBBING BY HAND

Grub axes and mattocks. The hoe is often used to dig up weeds or roots, but for roots that go deep into the ground it is too broad and too light to do the work well, so the grub ax or grubbing hoe is used for this purpose. The grub ax is like the mattock, except that the "cutter end" is omitted. This makes a light tool, but an unbalanced one. The grubbing hoe should be used entirely for grubbing.



Fig. 10. Long Cutter and Short Cutter Mattocks

Mattocks are known under two names: the "short-cutter" mattock, Fig. 10, and the "long-cutter" mattock. They vary in weight from 5 to 12 lbs., the difference being due to the length of the cutting blade, which is about 4 ins. long in the short cutter, and 6 ins. or more in the long cutter. This tool is primarily designed for grubbing, and is much more efficient than a pick. With the mattock small roots can be cut with either end of the tool, but the "cutter end" or "ax-like end" will cut through larger roots. However, extremely large roots should only be exposed with the mattock, and then cut with an ax. In digging around a root to expose it, the digging blade of the mattock cannot only be used like a pick for loosening the dirt, but like a hoe to draw out the loose dirt. A shovel is of little service in *such places.*

Most stumps can be blasted cheaper than they can be dug up by hand, and stump pullers will frequently save

money over blasting, yet there will always be some grubbing done by hand, just as with innumerable machines for excavating earth there is always some work that needs the pick and shovel. Stump pullers should be used wherever it is possible to do so, but even when they are so used many stubs and roots must be dug up with the mattock, especially when scrapers and elevating graders are to be used for moving the earth. It is true that many smaller roots can be torn up and rooted out by using a rooter plow that is manufactured by the different plow companies, but still some of this work must be done by hand and the mattock should be used for it.

Hand grubbing aided by frost. (*Engineering and Contracting*, May 25, 1908.) When stumps are grubbed by hand, the tools to be used are a long cutter mattock, an ax, and a round pointed shovel. A long heavy lever should also be cut in the woods to be used in prying up stumps, after they have been partially loosened. This will be found a great help. Two men should always work on one stump, as their pace will be faster than when a man works alone, and they will do more efficient work with a lever.

When grubbing is done by hand, and the stumps can remain in the ground throughout the winter, in cold climates, much work can be saved by digging around the stumps in the fall and cutting off a few of the main roots. The frost then gets under the stumps through the excavation made, and this heaves the stump partly out of the ground, making the rest of the work comparatively easy in the spring. Old stumps can be taken out in this way easier than green ones. In clearing land and when able to let the stumps remain in the ground for several seasons, by doing a little work around the stump each autumn, farmers can let frost heave the majority of the stumps almost entirely out of the ground in two or three years.

Grubbing standing trees. Frequently old trees on lawns and in parks where it is not practical to blast have to be taken out by hand labor. It is of great advantage when doing this work to grub out the stump before the tree is cut. A ring of earth 2 ft. wide about the stu

is excavated with shovel and mattock, and all roots encountered are cut through in two places, first at the outer edge of the excavation and then as close to the trunk of the tree as is needed to give room for the excavation. As the work proceeds two or three roots that appear capable of holding the tree in place are selected to be left until last. When all other roots that can be reached are removed these are cut and the tree falls, often breaking thick vertical roots that could only be reached with great difficulty. Another advantage of this method of procedure is that if blocks or logs are placed for the tree to fall across, its weight will frequently lift the stump clear of the hole which may be back-filled before the stump is cut from the trunk. The roots remaining in the ground are generally small enough not to interfere seriously with a plow. Working this way one man can dig out, cut up for removal and back-fill the holes of from one to two old apple trees, approximately 2 ft. in diameter, per day. Root systems of old apple trees vary greatly in extent as does also the amount of wood they contain. Many are hollow, making them easy to cut up; but if they break in falling, leaving the stump in the ground, this saving in cutting up is more than offset by the cost of removing the stump.

It is sometimes feasible to undermine tall trees in the autumn on the side away from the prevailing high winds. During the winter or spring a strong wind will uproot such trees, effecting a great saving in the cost of grubbing.

Cost of clearing and grubbing at Brockton, Mass. The following brief abstract is from *Engineering News*, May 18, 1899: In the work for the filter beds at Brockton, Mass., 1894, there were 18.8 acres cleared and grubbed, of which 14.4 acres were standing pine. The trees varied from 6 to 24 ins. in diameter, and there were about 3 trees per sq. rod. or 480 per acre. When cut up, about 35 cords of wood per acre were obtained. The total cost of pulling and disposing of stumps was \$112 *per acre* or 23 cts. per tree. Wages of laborers were \$1.50 a day.

Cost of clearing and stripping, Spot Pond Reservoir.

In *Engineering News*, Dec. 12, 1901, Mr. C. M. Saville gives the cost of some work on the Spot Pond Storage Reservoir, near Boston, Mass. Laborers were paid \$1.75 and teams \$4.50 per 10-hr. day, and worked by the day under a foreman who received 10% of the labor cost for superintending the men and furnishing tools. The following figures show how inefficient the men were under this day-work method.

The shores of the reservoir were stripped of about 40,000 cu. yds. of earth which was 80% loam and 20% gravel and hardpan, hauled 1,000 ft.; and the cost was 55½ ct. per cu. yd. Another piece of very compact earth cost 62 ct. a cu. yd., although the haul was only 300 ft.

Clearing and grubbing 5 acres of densely wooded shore, cost \$492 per acre, small trees being chopped down, while large ones were undermined, their roots cut off and the tree pulled over by block and tackle, hitched to the tree top, with 20 or 30 men pulling. It cost beside this \$100 per acre more to cord up (1,000 cords) the marketable timber, and burn the refuse.

Hauling (800 ft.) and laying several thousand cu. yd. of riprap (18 in. thick) cost 68 ct. per cu. yd. The labor of seeding 28 acres, including raking and removing roots and stones, cost \$43 an acre.

Cost of grubbing for elevating grader work. *Engineering and Contracting*, Dec. 25, 1907, gives the following:

The job to be described was the clearing and grubbing on nine miles of railroad construction. Most of the line was through cultivated fields, but in 11 places varying in length from 100 to 4,600 ft. there was clearing to be done. In all there were 14¼ acres, of which 1¼ acres were over areas upon which embankments were to be made, while 13 acres were in cuts, hence there was both clearing and grubbing to do. The excavation was to be done by an elevating grader, and the grubbing had to be done more thoroughly than it would have been, if other methods of excavating had been employed.

The first work done was to clear the ground. Most of the brush was burned, but some brush and the

were rolled to the edge of the right of way and piled up. The trees, of the size of 6 in. or more in diameter, numbered about 40 to the acre; but there was a very rank undergrowth of bushes and saplings, the stumps and roots of which all had to be grubbed. The work was done by contract, and the men working upon the job were not experienced woodsmen or axmen, but were such as could be obtained at the labor market centers. Many of them were foreigners. The wages paid to the foreman was \$2.50 and to the men \$1.50 per ten hour day. A waterboy was paid \$1.00 per day. In the clearing gang an average of 12 men were worked, some using axes and others brush hooks. The brush was piled by hand, no forks being used, and the logs, few being more than 3 ft. in diameter, were cut short and rolled by means of hand sticks. Some few were carried by the men with these sticks.

The cost of clearing per acre, for 14¼ acres, was:

| | |
|-------------------------------|---------|
| Foreman | \$ 4.59 |
| Men | 27.10 |
| Water boy | 1.36 |
| | <hr/> |
| Total clearing per acre | \$33.05 |

The grubbing was done by a gang of men averaging 15. The wages were the same. Some few of the larger stumps were blasted, and their roots afterwards grubbed. Dynamite, costing 15 cts. per lb., was used for this blasting. No separate record of the stumps that were blasted nor of the explosive used for each was kept, only the total cost of the explosives being kept, and the labor of blasting was included in with the other grubbing. About 6 stumps were blasted to the acre.

The cost of grubbing per acre, for 13 acres, was:

| | |
|-------------------------------|---------|
| Foreman | \$ 4.54 |
| Men | 38.84 |
| Water boy | 1.81 |
| Explosives | 2.54 |
| | <hr/> |
| Total grubbing per acre | \$47.73 |

The men used long cutter mattocks and short handled

shovels in grubbing the stumps and roots. There is but little doubt that this cost of grubbing could have been reduced by the use of a stump puller, but the contractor did not own one, and thought the job too small to justify purchasing such a machine.

The total cost for clearing and grubbing was as follows:

| | |
|------------------|---------|
| Foreman | \$ 8.74 |
| Men | 62.54 |
| Water boy | 3.00 |
| Explosives | 33.00 |

Total clearing and grubbing per acre .. \$76.60

The tools used for this work cost about \$50, but with the exception of the brush hooks, they were all used on other work, hence to charge half their cost to this job would be sufficient. This means a charge for tools of \$2 per acre, making a total of \$78.60. This work was being done at the same time that grading and other construction was going on, hence the charge to be added for general expense, such as superintendence and office expenses would be small.

This clearing and grubbing was not paid for by the acre, but the work was included with the grading, and the price of excavation covered the clearing and grubbing. There was 90,000 cu. yds. of earth excavation on the 9 miles of road, hence the cost of clearing and grubbing amounted to about $1\frac{1}{4}$ ct. per cu. yd. of earth. If elevating graders had not been used, the cost with the same forces doing the work, would have been less than 1 ct. per cu. yd.

Another example of clearing and grubbing is given below. Five acres of woodland were to be cleared and grubbed of all bushes and worthless saplings, vines and briars. The undergrowth was dense. None of the trees were to be cut. The clearing was done by a contractor, but he was paid "force account," that is, actual cost plus a percentage for his work. The wages paid were the same as in the example just given. The brush, old logs and other debris had to be burned, and care had to be exercised that none of the trees were injured,

the woods was to be made into a park. The cost of clearing was as follows, per acre:

| | |
|-------------------------------|---------|
| Foreman | \$ 7.25 |
| Men | 54.06 |
| Water boy | 3.00 |
| | <hr/> |
| Total clearing per acre | \$64.31 |

This work was done in the fall of the year, and the weather was exceptionally good. The following spring the ground had to be thoroughly grubbed in order to plant grass seed in the woodland. This work was done with mattocks, every inch of the ground being gone over, brier roots, old stubs and all roots of bushes being dug out. There were also a few old stumps that had to be taken out, but the work was mostly the small surface roots of bushes, saplings and briars. After the ground was gone over with mattocks, steel rakes were used to rake out the roots, and put them in piles. Wheelbarrows were then used to haul them away to a waste pile, where they were afterwards burned, when they had dried sufficiently.

This work had to be well done, or else the grass seed would not make a good sod; that an excellent sod was obtained in one season, was evidence that the work was well done. Company forces did this grubbing, the rates of wages being: Foreman \$2.50 for 9 hours, and laborers \$1.50 for 9 hours. The cost of the grubbing per acre was:

| | |
|-------------------------------|---------|
| Foreman | \$ 4.20 |
| Men | 51.30 |
| | <hr/> |
| Total grubbing per acre | \$55.50 |

This gives us a total cost for clearing and grubbing of \$119.81 per acre. To this should be added \$2.00 per acre for tools.

If this work had been done by contract, it could not have been done better, but there is little doubt that the *cost would have been less.*

Clearing for an earth dam in Oklahoma. The following is from an article by Mr. J. W. Holman in En-

gineering and Contracting, Nov. 13, 1912, on constructing an earth dam at McAlester, Oklahoma:

The cost of building the dam, compiled from force records, etc., which were made up during the construction of the dam, is given herewith. The contractors contend that the cost here given is about 10 per cent too low, and that probably is true.

Clearing borrow pits, 9 acres:

| | |
|----------------------------------|----------|
| Feed | \$ 90.00 |
| Labor | 262.50 |
| Repairs, etc. | 24.80 |
| | <hr/> |
| Total for clearing 9 acres | \$377.30 |
| Cost of clearing per acre | 41.92 |

Stripping 9 acres 6 ins. deep, total 7,260 cu. yds.:

| | |
|---|-----------|
| Feed | \$240.00 |
| Labor | 525.00 |
| Repairs, etc. | 58.00 |
| | <hr/> |
| Total for stripping 7,260 cu. yds. | \$823.00 |
| Cost per cu. yd. | 11.3 cts. |

Preparing dam foundation, 2.1 acres; clearing:

| | |
|------------------------------------|----------|
| Feed | \$ 18.00 |
| Labor | 31.50 |
| Repairs, etc. | 4.60 |
| | <hr/> |
| Total for clearing 2.1 acres | \$ 54.10 |
| Cost of clearing per acre | 25.80 |

CHAPTER V

BURNING AND CHAR-PITTING

Burning stumps. The following is from Farmer's Bulletin 381, published in *Engineering and Contracting*, Dec. 22, 1909:

Removing stumps by hand is a slow and costly method when the stumps are of small size and is out of the question for the large stumps of fir and other trees up to 5 and 6 ft. in diameter. In the last condition the principal up-to-date methods are burning, blasting and pulling or some combination of these. Burning is considered the best way to remove pine stumps which have a large amount of turpentine, as this greatly assists in the process, and the long, deep roots of these trees are a great hindrance in pulling. In regard to burning these stumps Mr. Ferris, of the Mississippi Station, says:

“The common method * * * is to dig a hole about 12 in. deep with spade or post-hole digger on one side of the stump, as close to it as possible, and to use this as a furnace for firing the stump. In digging these holes it is necessary that the dirt be removed from as much of the surface of the stump as possible, so as to allow the fire to come in direct contact with the side of the stump for at least 6 ins. An ordinary turpentine dipper on a suitable handle makes one of the best implements for removing this dirt.”

This is a rather slow process, but may be greatly hastened by boring a slanting hole through the stump from the opposite side to the fire hole. For boring, the *Mississippi Station* has used the simple machine shown in *Fig. 11*, invented by J. W. Day. It is thus described: A 2-in. ship auger is welded onto one end of a 3/4-in.

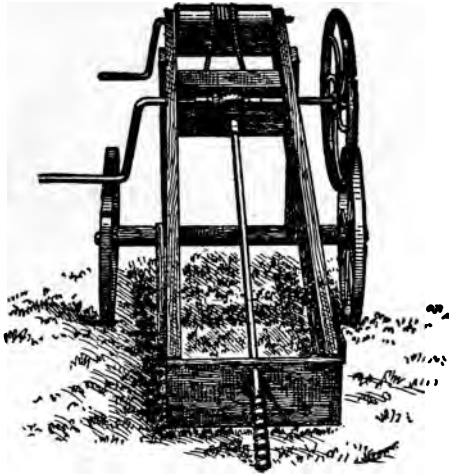

Fig. 11. Portable Boring Machine for Boring Stumps for Blasting

iron rod 6 ft. long. Four inches from the other end of this rod a collar is welded and the end of the rod passed through an iron box fastened to a movable frame about 18 ins. square. A bevel gear is then fastened to the extreme end of this rod either by a key or set screw and works into a second gear of the same kind fastened on a horizontal shaft. This horizontal crank shaft is made of 1-in. iron rod bent at one end to form a handle, with a fly wheel fastened on the opposite end. It works through two boxes fastened to the movable frame and slides down the main frame as the auger bores into the stump. The upper end of the machine is elevated about 5 ft. and stands on two cart wheels, on which it is easily rolled from stump to stump or from field to field by a single individual. This elevation of the frame helps to brace it against the stump in boring, raises the crank shaft to a height at which it can be most easily turned, causes a slight pressure to be constantly exerted against the auger, and makes it possible to bore the hole diagonally into the stump. At the extreme upper end

the frame is a small windlass with ropes attached which is used for pulling the auger out of the stump.

This machine was used to aid in clearing 2.3 acres of land which had been cut over about seven years before. The sapwood had decayed, but the balance of the stump above ground and all below was sound. On this plat there were 158 stumps that required boring. These averaged 13.6 ins. in diameter, and the length of hole bored averaged 19.7 ins. the total cost being less than \$8 an acre, figuring labor at \$1.50 per day.

For burning the large stumps of fir, etc., in the Pacific Northwest, a quicker method is used, which consists of boring two intersecting holes, as in Fig. 12 and burning

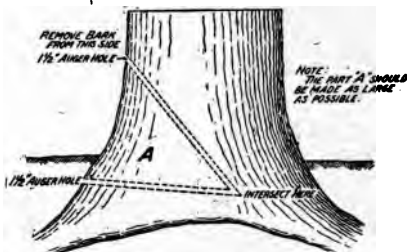

Fig. 12. Sketch Showing Method of Boring Stumps for Burning

by starting a fire at the intersection with the aid of red hot coals or a piece of iron heated to a white heat. After the part marked *A* is burned out the fire is maintained by filling the space with bark and litter. While the method first described generally results in burning the stump low enough to allow of cultivating over it in the case of pine stumps, the method used on the western trees leaves the larger stringers with their smaller roots to be pulled out by steam or puller, or "they may be entirely burned by digging away the earth and rolling a small log alongside of the root."

Char-pitting stumps. Bulletin 170 of the Washington State Agricultural Experiment Station gives the following: Of the various methods of removing stumps *none seems to be more economical than the char-pitting method of burning them, according to Mr. Geo. A. Nelson,*

County Agriculturist of Wahkiakum County, who has used the method to good advantage in his county.

In preparing the stump for burning, the bark should be removed from the base, and on some stumps it is necessary to remove some of the dirt. Thus the fire may be started so near the bottom that it will start burning under the main part of the stump and the roots. Any kind of wood that forms good coals may be used. It should be cut short and either stood up around the stump or laid on its side. The wood may be piled so as to start the fire entirely around the stump or in one place, as may be desired. The former method will burn the stump out more rapidly, but takes more wood and more time to prepare. After the wood is placed it may be covered with fern or other similar material, and a thin layer of dirt should be placed over it, with the exception of leaving a place large enough to start the fire. Only a light coating of three or four inches of dirt should be put over the fire, and this should not be piled against the stump over 18 ins. high. As the wood burns down, the fire will break through the dirt in places, and it will then be necessary to apply more dirt to cover it. As the fire burns into the stump, more dirt should be shoveled over it. Should the fire burn higher on the stump than where the dirt is piled, it should be put out, instead of trying to cover it by piling the dirt higher. The fire should be covered at all times, and never be allowed to burn into an open blaze; as when it does much of the fuel is burned up and the heat lost. *The object is to confine the heat.* When this is properly done it becomes intensely hot around the base of the stump. As the main part of the stump is burned out, care should be taken to keep the roots covered properly, so that they will all burn out.

Another method of char-pitting stumps, which has been recommended by the University of Idaho, is to saw the stump off as near the ground as possible, and skid or lift the upper part of the stump off the base from two to four inches, using stones to hold the two pieces of the stump apart. Then in the summer, when it is dry, a fire can be started between the two parts of the stump. *The two burning surfaces radiate heat upon each other and*

thus maintain continuous combustion. The top of the stump gradually settles down, burning the roots out.

Only soil that contains a considerable amount of clay is suitable for char-pitting. Sandy or gravel soils are not adapted to the work. This method has proven equally successful in Wahkiakum County on both the hill and bottom land. It has proven especially successful on the reclaimed tidelands. The quality of the stumps and the nature of this soil makes it especially adapted to the char-pitting method.

The efficiency of the char-pit method of burning stumps.¹ The char-pit method applies economically to stumps over 1 ft. in diameter. Smaller stumps can be removed more cheaply by pulling with horse and capstan, or donkey engine.

In tests of char-pitting in the western part of Washington, all bark was removed from the stumps for a height of about 2 ft. above the ground. Enough dry kindling wood was gathered from the ground and "down logs" to form a ring 6 to 8 ins. in thickness entirely around stumps where bark had been removed. After kindling was placed, it was closely covered with clods and thick flakes of clay dug near the stump with a farm shovel, leaving only open a small space, about 1 ft. wide, for igniting the kindling. While the kindling wood on first stump was becoming thoroughly ignited, other stumps were similarly prepared and the kindling fired. After kindling was thoroughly burning, the 1-ft. opening was also covered with earth to drive the fire around the entire ring of kindling like a charcoal pit. When the rising smoke indicated that the kindling around the stump was well lighted, additional dirt was placed closely around the stump to keep all the heat inside the casing of earth.

None of the heat escaping, the fire grows hotter from the burning stump and slowly destroys the stump. Tall stumps will burn entirely off just above the earth casing, and the upper unburned part of the stump can be readily

¹ Report of tests made for Citizens' Club, Chehalis, Wash., under the supervision of Prof. H. W. Sparks, Superintendent of Department of Farm Demonstration of the Washington State College, and Mr. Harry Thompson, Expert, Office of Farm Management, United States Department of Agriculture. Reprinted in *Engineering and Contracting*, Oct. 18, 1911.

burned up in log heaps. The bed of coals left where the crown has burned off should be covered closely with additional earth and all roots that are exposed above ground should also be similarly covered with from 4 to 6 ins. of earth, and the fire will follow roots to their ends clear below plowing depth.

The first day of the tests two men prepared and fired 32 large stumps. The second day they examined the 32 burning stumps and added dirt to the banking where necessary, and prepared and fired 26 more stumps; the third day, 24 stumps; and the fourth day, 18 stumps—a total of 100 stumps. Every day they visited the burning stumps and prepared and fired more stumps.

Data were computed on the preparing, firing and tending of 100 stumps kept burning continuously at an average cost of less than 50 cts. per stump. These 100 stumps averaged 46 ins. in diameter at the base, by actual measurement.

These tests were made on a shot clay soil, on the hill land of the south side of the Chehalis River, about one mile from the Adna station on the Northern Pacific Railway.

Reliable information of still lower cost per stump by the char-pit method of burning has been received from Mr. J. W. McCutcheon, also of Adna, who reports clearing off 200 stumps at a net cost of \$70, an average of only 35 cts. per stump.

Enough data have been obtained fully to establish these facts concerning the char-pit method of clearing logged-off lands wherever soil conditions are favorable.

First: The economy of the method, which can be conducted without high-priced labor and at seasons when other farm work is not heavy, or can be done at all seasons in connection with other farm work.

Second: The char-pit method leaves the surface of the ground practically undisturbed, and prepares highly fertilized seed beds for grains, root crops, fruit trees and grasses.

Extensive investigations lead to the conclusion that while nearly every tract of logged-off land presents *so* different features, a sensible adaptation of the follow

three approved methods will accomplish their clearing at minimum effort and cost:

First: By char-pit method, where economy and not time is the important factor.

Second: By skilled use of powder and donkey engine, where land must be cleared quickly.

Third: Where land to be cleared is second growth slashing, with stumps 4 to 14 ins. in diameter in great numbers, they can be best cleared with a good horse-power capstan with wire cables, chokers, etc., which can be bought complete for two hundred dollars. If larger stumps are occasionally met, they can be blown to pieces and pulled, or char-pitted, as the owner may desire.

In *Engineering and Contracting*, Sept. 20, 1911, some further facts about the process are published, of which the following is an abstract:

Mr. F. B. Holbrook, a real estate agent, has a "demonstration camp" near Globe, Ore., where "during the past thirty days Mr. Holbrook has removed 400 stumps, 2 to 6 ft. in diameter, for the extremely low cost of 75 cts. each." This includes the removal of all the roots, which are completely burned out, often for a distance of 50 ft. from the parent stump and to a depth of 2 ft. It is stated that if these huge stumps had been removed by blasting it would have cost \$4 per stump for powder alone.

After the fires are once started in the stumps, "one man with a long handle shovel can attend to 600 stumps, which is the average number found on a 20-acre tract." It is stated that there are 40 to 50 big fir stumps per acre, also that one man can char-pit and destroy every stump and fallen log on a 10-acre tract in five months.

The problem of destroying fallen logs and brush has been greatly simplified by Mr. Holbrook. By using small charges of black powder, he splits the largest logs, and this, together with other economies practiced, has reduced this part of the clearing process by more than 50 per cent.

The actual work of char-pitting may be so divided that *it can be carried on the year round. In the rainy season the bark should be removed from the stumps, and around*

each stump a small trench dug. Both these operations can be best carried on in wet weather. Then in the following June or July, when everything has been dried out thoroughly, pile the bark, which has been removed from the stump, around the stump and cover it lightly with freshly spaded earth. This done, set fire to the covered bark and the process is on. Watch the fire and keep it well covered with earth, and in from one to three weeks,

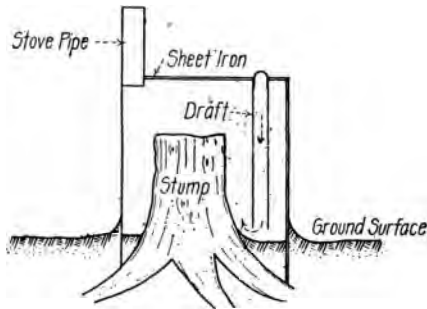

Fig. 13. Form of Stump Burner

owing to the size of the stump, it will burn up, roots and all.

A simple portable device for burning stumps. In *Engineering and Contracting*, Oct. 18, 1911, Hiram Phillips describes the device shown in Fig. 13 as follows:

The device was made out of an old "Wilson" down draft heater by removing the bottom, placing it over the stump and packing the earth firmly around it, preferably using wet clay firmly tamped.

It only takes a few minutes to place the burner and to start the fire. The time required to burn out a stump varies according to the amount of moisture in the wood and the draught (height of stove pipe of the burner).

The writer has burnt dry oak stumps 36 ins. in diameter completely out in 10 hours. When the earth is comparatively dry the roots will be consumed 6 ins. or more below the ground surface.

There is no danger from flying sparks carried by hi

winds. By clearing the ground a few feet around the stump this burner can safely be used without danger of starting forest fires.

The time of burning a stump can be materially shortened by adding fuel occasionally. An ordinary rain will not interfere with the successful operation of the burner. It is the opinion of the writer that under average conditions one active man could operate at least 25 of these burners simultaneously.

A blowing machine for stump burning. From Bulletin No. 8 of the Washington State Agricultural Experiment Station, by Harry Thompson, the following has been taken:

About the first method used by the early settler in destroying stumps was to bore intersecting holes into the stump as far as he could and by the use of oil, pitch splinter or hardwood coals start a fire at the intersection of these auger holes. By careful manipulation of these fires he was able to burn the top and crown of the stump, separating the large roots that were afterwards removed by the use of a team and blocks or a stump-puller. This method is very rarely used at the present time in Washington.

Another method employed by the settler and used in some localities at this time is to split the stump by a small charge of powder, after which it is set on fire and kept burning by piling into the cracks small logs, brush and other stuff that is picked off the ground. After the burning has done all that it will do, the remaining roots are pulled by means of a team or by a stump-puller.

As early as 1870 there was a patent granted upon a stump burner that consisted of a hood of sheet iron to set over the stump. Since that time several similar contrivances have been patented, none of which are in use today upon the fir stumps of Washington. In cases where they have been tried they have only succeeded in burning the stump off at the surface of the ground, leaving the roots in the soil to be taken out by some other method. Another objection to the use of the hood upon *the fir stumps is the great size required to cover the large stumps.*

For some years there have been appearing from time to time in various publications formulas for the destruction of stumps by the use of chemicals. It was claimed that by treating a stump with saltpeter or a mixture of sulphuric and nitric acid that it could be burned out completely to the tips of the smallest roots. The method was to bore an auger hole into the stump, fill it with the mixture and allow it to stand for several months, after which it was to be covered with coaloil and set on fire. Many have tried both these methods with no success whatever.

A "blowing machine" for burning stumps usually consist of a gasoline engine, a blower, a distributor and several lengths of rubber hose with short lengths of pipe upon one end. Some of the machines use tin conductor pipe connected by short pieces of rubber hose instead of the long lengths of rubber hose, as it is cheaper. There is usually one or more patented devices in use about each of these machines.

The air from the blower is divided into an equal number of parts by the distributor and forced through the lengths of hose to the nozzle and upon the fire.

One method of operating is to bore holes with an inch and a quarter auger into the roots of the large stumps at a sufficient depth below the surface to permit of plowing, the earth having first been removed from around the stump to a depth of from 12 to 18 ins. A fire is then started at the bottom of the holes by means of a hot iron and the nozzles placed at the openings. The air blasts keep the fire going. While these are burning, four holes are bored about 2 or 3 ft. above the first ones so that if they were bored far enough they would intersect and fires started in them in the same manner. After these holes burn to an intersection they will continue burning after the air blasts are removed.

Another method of operating is to chop a notch into the stump at several points and to roll short logs against it at these points, start fires between the logs and the stump and direct the blasts of air upon the fires.

The destruction of the stump by this method does not take place as quickly as is popularly supposed or

quickly as is claimed by the inventors of the process. While a great heat is generated it seems impossible to hasten the burning beyond a certain point. As most of the stumps to be burned are quite old and contain a large amount of water, even in the summer months, the best results are obtained when using this machine by operating it continuously day and night until the stumps fired at one time are completely consumed.

One man can operate a machine of this kind where only 5 or 6 lines of hose are used. Where 12 or 14 lines of hose are used two men are required most of the time.

Although several of these machines have been sold throughout the country, very few of them have been operated successfully or have met the requirements of the purchasers. As a result most of these outfits have been abandoned for burning stumps.

The principal objection to this method of burning stumps is the difficulty of burning the roots far enough below the surface to admit of cultivation. This can be done only where the stumps root deeply or where the soil is a clay.

These outfits cost from \$350 to \$500 complete in every way.

The cost of gasoline and lubricating oil to operate the outfit is approximately \$1 per day of 10 hours.

The following was the cost using this method in Snoqualamie River Valley:

Stump pasture had been slashed and burned over two years before.

Large fir stumps deeply rooted in sandy, well-drained soil.

Work was done in June, 1910.

The 20 acres that had been slashed averaged 12 large stumps per acre by actual count. There were no small stumps, owing to the fact that that land had been used for a pasture for a number of years.

Outfit: 4½ horse-power gasoline engine, blower and *air distributor*; twelve lengths of two-inch rubber suction hose with eight-foot nozzles; twelve lengths of three-

quarter inch rubber hose with half-inch pipe nozzles; augers, tools, etc. Cost of outfit \$500.

The crew consisted of two men.

| | |
|---|---------|
| Labor of two men, 115½ hours at \$0.25 per hour | \$57.75 |
| Gasoline and lubricating oil | 10.80 |
| | \$68.55 |
| Total for 9 stumps | \$68.55 |
| Cost per acre (12 stumps) | \$91.40 |

Experiments in clearing land with a stump burner.

The following is from a report by Mr. W. H. Lawrence, Bulletin No. 93, Agricultural Experiment Station, State College of Washington, abstracted in *Engineering and Contracting*, Sept. 27, 1911:

The stump burner used in the experiments. The stump-burner consists of a 1½ h.p. gasoline engine with 13-in. flywheel and adjusted to run 650 revolutions per minute; a circular fan (No. IV American blower with 8½-in. fan and 2½-in. pulley) provided with a patent wind distributor tapped to attach five lines of 1½-in. hose; hose couplings; pieces of 1½-in. rubber hose of different lengths; a number of pieces of galvanized iron tubing; a few small iron plates, and several lengths of boiler tubing slightly curved at one end, which are used as blow-pipes. The hose couplings are used to attach the rubber hose to the wind distributor and the blow-pipes. The tubing, which is of the right diameter to fit inside of the hose tightly, is connected with short pieces of rubber hose 18 to 24 ins. in length. By using tubing and short pieces of hose of variable lengths the right size to telescope, provision is made for varying the length of line of hose as desired. The lines of hose are very light and easily adjusted, since no couplings are required. The tubing connected by short pieces of hose also prevents doubling, thus retarding or stopping the current of air. From the description, it is plainly seen that the stump-burner is small, light in weight and very cheaply constructed. At a later date the blower was coupled with a 2-h.p. gasoline engine and mounted on a truck. With the latter engine a few trials in operati

a wood-boring auger by power were made as described later.

The plan of work. The machine was set in a convenient position to burn several stumps at a time. Auger holes, 2 ins. in diameter, were made in the base of the stumps. The boring was done by hand. The auger was directed inward and downward in order to extend the hole as low and as far as the center or even three-fourths to seven-eighths of the diameter when the stumps were of large size. Short pieces of hose with couplings on one end were attached to the wind distributor, and sections of galvanized iron tubing inserted, after which alternate sections of hose and tubing were added in order to make the lines of hose of sufficient length, after adding the last section of hose with the blow-pipe attached, to reach the stumps. A fire was then started in each auger hole by using live coals of wood or kindling. The machine was set in motion in order to fan the fires. In burning, it was the plan to drive the fire to the center of the stump and to confine it as long a time as possible, preventing, if possible, the forming of a large opening at the point of entrance. This was accomplished by inserting the blow-pipe into the opening as fast as the burning would allow. Occasionally, burning around the blow-pipe takes place more rapidly than desired. In such a case it was found advantageous to use an iron plate of sufficient diameter to cover the hole. The plate has an opening in the center large enough for the insertion of the blow-pipe. By keeping the fire confined it is less difficult to drive it into the main roots than when allowed to burn in the open. The blow-pipes must be moved frequently in order to keep the fire burning briskly and to the best advantage.

When the fire is confined and the air is constantly forced into the small space, the heat becomes so intense that the gas burns as it leaves the blow-pipe forming a long flame. The heat generated under such conditions is intense. Small rocks were readily melted when placed *in the stumps* which were burning briskly. The intense *heat produces charcoal very rapidly.* The layer of char-

coal apparently retards the rate of burning. It was found advantageous under some conditions to frequently remove the layers of charcoal, using a long-handled iron chisel.

After the center of the stump has been partially burned out and the opening is large enough to permit the introduction of kindling, it is an excellent plan to insert as much small wood as possible. The bed of coals formed by the kindling aids to maintain an intense heat. Excellent use of the debris can be made in burning the roots after the crown of the stump has been largely destroyed. From a very limited trial, it is evident that charcoaling and pitting the roots may be practiced to a good advantage at this stage in the use of the stump-burner.

Burning large logs is also quite readily accomplished. The best results were obtained by boring a hole as near the underside of the log as possible and about three-fourths through it, after which the fire was controlled as described above. Small debris (sections of dead limbs, etc.) may be inserted into the log to a good advantage after the fire has made a cavity of some size. Again, as in burning stumps, it is advisable to remove the charcoal by using the long-handled chisel.

After the logs have been burned into sections and reduced in weight so that they can be handled to a good advantage, the tops of the stumps (which are seldom entirely burned) may be piled with the other debris, consisting of all small stuff, together with the small trees which have been cut into sections for convenience in handling, and burned. It is advisable to use the outfit only in case marked results cannot be obtained in burning the pile.

Kind and condition of logs and stumps burned. Trials were made in burning both cedar and fir under various conditions. The first trials were made in a marsh, in burning cedar stumps and logs which were so saturated with water that it was impossible to burn them without the aid of a machine. The intense heat, generated by the burning gas and wood (especially when the fire was confined), produced a heat which dried the wood

faster than burning took place. This trial lasted for a period of eight days. The results obtained under such conditions were encouraging. Better success, however, was met with in burning fir.

Stumps of various ages and conditions were burned. It is found that the greater the age of the stump, the more quickly it could be destroyed. The condition of the older stumps was found to vary from solid to badly decomposed, by the action of the elements, assisted by saprophatic fungi and wood-boring ants. Stumps consisting of fir wood which have not absorbed very much water are easily burned. Naturally the more pitch they contained the more rapidly combustion took place. Those stumps, however, in various stages of decay and full of fungi, and in many cases well saturated with water, were usually more difficult of destruction. Concerning the various conditions of fir stumps, it can be said that the general appearance is no indication of the ease with which they may be burned. In several instances, stumps apparently sound, as indicated by external appearance, were so thoroughly saturated with water throughout the greater portion of the heart wood that, after the holes were bored, the water continued to drip or even in some cases to run from the wood for a period of several minutes and even hours. The intense heat which can be generated by the aid of such a machine is sufficient to destroy the most water-soaked and decayed forms, although the progress is much less rapid under such conditions.

Two green fir stumps, one 5 ft. in diameter, 5 ft. above the ground, 22 ft. around the base at the ground, with 12 large roots, and the other 4½ ft. in diameter 6 ft. from the base and measuring a little under 19 ft. around the base, with 8 roots, were burned off in a 12 hours' run. The 20 roots, with the exception of three very large ones, were burned below the level so that the plow would go over them. A run of 4 hours with 4 lines of hose was required to finish the work. The cost to do *the work*, basing the cost of labor at 30 cts. per hour, *and a charge of 70 cts. for gasoline and oil*, the average *cost of removing the stump* would be \$2.60 each.

Twenty-two hours' work on a green fir stump about 5 ft. in diameter, with large spreading roots, gave less encouraging results. The small fir burned out completely, even the smaller roots penetrating to a depth of 3 ft. The crown of the cedar burned, separating the roots but not low enough for a plow to pass over them. The roots of the large fir were water-soaked, hence burning was almost impossible. In both cases the crowns were burned out, separating the roots. Basing cost on above mentioned price, the average cost was \$2.73.

The sixth test was made on cedar stumps, one 2½ ft. and one 4 ft. in diameter, and a green fir 5 ft. in diameter 6 ft. from the base. It took 28 hours to complete the work. The roots were not burned out. During this test a delay of several hours was caused by a disabled engine, thus making it impossible to control the fire to the best advantage. The cost per stump was \$2.93 in this trial.

A group of five old fir stumps, one 2 ft., two each 3 ft., and two each 2 ft. 6 ins. in diameter, each 9 ft. high, more or less decayed and thoroughly soaked with water, were burned low enough to destroy the crowns, thus separating the roots, in a 22 hour run. These stumps were in such a water-soaked and decayed condition that the fire would not burn after the blowers were removed. The roots could not be burned, owing to the abundance of water in the soil. The average cost of doing this work was \$1.56 each.

Another group of five fir stumps, 9 ft. tall, with an average diameter of 3 ft. 6 ins., mostly sound but water-soaked, were burned, as low as the soil conditions would permit, in 27 hours. Again the crowns were destroyed, leaving the roots separate. The average cost of this work was \$1.70 per stump.

Five large fir stumps, each 10 ft. in height, averaging 5 ft. 2½ ins., 3 ft. from the bases, were burned off so that all the crowns were destroyed, leaving the roots separate, many of which were also largely burned up. Forty hours' time was required to do the work. The cost of burning done on each of these stumps was \$2.80.

Conclusions. (1) The economical destruction of large stumps is the most perplexing problem in lar

clearing. By the use of the stump-burner the crowns of stumps are readily destroyed, thus leaving the roots separated. The roots may be burned below the surface so they will not interfere with cultivation, or they may be removed by the use of small quantities of stumping powder or some other convenient method—the method to be determined by the cost. The stumps of the smaller growth may be removed at this time and by the same method. The large logs may be burned in sections, the smaller ones cut into convenient length for handling, and the entire mass of debris, including the small rubbish, collected in piles and burned. By this method, the important problem of putting the entire mass into a condition so that it may be handled and burned quite readily is accomplished, leaving the land ready for the plow.

(2) To operate the outfit described for a period of 10 hours requires the services of one man, 2 gals. of gasoline, and a small quantity of cylinder oil. The cost for labor, at \$2.00 per day, and 2 gals. of gasoline and a small quantity of cylinder oil would not make the cost of operating exceed \$2.50 per day. In operating a five-line burner, the operator has time to get together the small refuse, and to saw into convenient lengths for handling the timber which is too small to burn to a good advantage with the aid of the machine.

It is believed from the experience gained in the use of this stump-burner that one large enough and equipped to operate 10 lines of hose at a time could be operated to a better advantage. The increase in cost of operation of a large machine would only exceed the original cost of operation of the five-line type by a small per cent. The large machine would require more gasoline and cylinder oil.

(3) The average cost of burning stumps was \$2.30. These stumps averaged 47 ins. in diameter. To remove such a stump by blasting would require about 33 sticks (25 lbs.) of powder at 13 cts. per pound. The powder *would cost* \$3.25. Considering the additional cost of *doing the blasting, filling the hole caused by the ex-*

plosion and the work required to destroy the stump after it has been removed by the use of powder, the practice of burning can readily be seen to be far the cheaper one. It is also to be noted that the purchase of the powder requires \$3.25 ready money. In using a stump-burner, the cost is represented very largely by labor at \$2.00 per day.

(4) Clearing land with a stump-burner requires good management in order to obtain good results. It is essential to place the blow-pipes in the right position in order to direct the burning to the best advantage and the right distance from the fire to insure rapid burning. The operator must be a good observer, industrious, and a steady worker to get the desired results.

Boring by power and burning. As concluded in the first part of this discussion, a stump-burner to be had at a reasonable cost, light in weight, and easy to handle, easily and cheaply operated, with which effective and rapid destruction of logs and stumps is accomplished, more nearly meets the requirements of the small land owner of limited means.

While the plan followed, to confine the fire and direct the current of air so that the greater portion of the interior of the log or stump has been consumed before the fire breaks out, has proven to be a successful and cheap method, a more rapid burning is desirable. It is also true that a stump or log, when properly bored so that the holes extend about three-fourths through and intersect at a wide angle and are so slanted that a good draft is possible when a fire is started at the intersection, will in many cases be partially consumed. A log will usually burn into sections, and the greater portion of the crown of a stump will be destroyed yet leaving the large roots still united.

A judicious combining of these two methods appeared feasible. It was very evident from experience and observation with both methods that the slow and tedious work of boring the holes by hand is responsible for a large portion of the time consumed. It was also evident that in some cases at least much more effective and rapid

work could be done by increasing the number of holes, in order to place the fires in different portions of the same piece of wood at the same time.

In order to accomplish the boring of a large number of holes, and at a rapid rate, some form of mechanical power must be employed. The engine, mounted on the truck with the blower was fitted with a sheave wheel. A flexible shaft about 7 ft. in length, provided with attachments to be driven by an endless rope, was fitted with a 1½-in. ship auger with a special shank about 18 ins. in length. The flexible shaft was then fastened to the stump or log to be bored by using a chain. It was then set in motion by the endless rope, guided by pulleys attached by leads to the nearest and most convenient obstacle, running on the sheave wheel of the engine. Running at a rate which did not make the task of holding the auger a difficult one, holes 15 to 18 ins. in depth were easily bored in 20 to 28 seconds. The average was 25 seconds. Using the same auger, and running it at the same speed, holes were bored to a depth of 30 to 32 ins. in 50 seconds to 1 minute in time. The average was 55 seconds. The more rapid rate at which holes were bored to a depth of from 15 to 18 ins. was due to the structure of the auger. The speed of the auger was sufficient to run shavings clear of the hole until it was inserted past the worm. Occasionally pitch seams or small knots cause the worm to clog. After insertion past the worm, however, the shavings would accumulate in the hole at the top of the shank and at frequent intervals were removed by withdrawing the auger, causing the worm to force the shavings out.

In order to remove the shavings while boring at this rate, it is apparently necessary to equip the auger with a much longer worm. In the limited number of trials made, it was somewhat surprising to note that such rapid work could be done with very little delay on account of heating the auger. Care must be exercised at all times, however, so that the auger will not be heated *enough* to injure the temper.

To combine the method of burning by keeping the fire

enclosed and briskly burning by use of the blower, and where the fire is given a natural draft as in the plan where intersecting holes are bored, a large fir log about $3\frac{1}{2}$ ft. in diameter was bored at four intervals about 6 ft. apart. The plan in boring was to make one hole straight into the lower side of the log about 4 ins. from the lower edge and three-fourths the distance through it. Three to five holes were then made by directing the auger downward from the upper surface, connecting with the cross hole, if possible.

The fires were started in the lower holes, the blower set in motion and the results noted. The fire, constantly fanned in the lower holes, advanced into the vertical holes very rapidly. In some cases all the vertical holes had not been made to connect with the horizontal ones. In these cases the rate of burning at first was greatly retarded until the fire ate its way through the solid portions of wood, connecting the vents. The fire when fanned by the blower is driven into all the openings, and very shortly every portion is lined with fire, which is also driven in short columns several inches in length from the mouths of the openings.

Although several minor trials were made with good results, the main experiment was conducted on a large log. Each set of boring gave slightly different results. In one case the lower hole was bored entirely through the tree. It was impossible to burn to advantage, since a draft could not be produced in the longer and vertical holes. In another trial, the holes were not bored as deeply as the cross holes. It took some time to get the fire burning briskly and to connect all these vents with the lower one, since several inches of solid wood had to be consumed before a draft was possible. However, where the cross holes met with the vertical vents, in every case, the fire started in the lower hole, advanced into all the upper ones very rapidly, and continued to burn briskly. In less than one hour the entire center of the log had been burned out, leaving a shell about 6 to 8 ins. in thickness. By making vents to direct the fire, burning can be easily controlled and made more effective.

by placing pieces of bark or sods of dirt over one or any number of the vents, thus stopping the drafts, and making a few new vents, if necessary.

The trials were very limited in developing this method, since they were discontinued by a disabled engine, followed by heavy rains, and furthermore requiring the attention of the entire station force to care for grain and other crops.

Owing to a slight unavoidable change in the plan of the work, it was impossible to continue the work on this method. Believing that the results obtained are worthy of further consideration, the plan of work and conclusions drawn, together with the method pursued, are herewith given.

Conclusion. This method of boring by power and burning is a very promising one, since:

(1) The machine used is easy to handle and serviceable.

(2) Much time is gained by boring the holes by power and makes it possible to bore large numbers of holes in a very short period of time.

(3) Directing the flame by making vents insures burning in the desired direction. By the use of these vents, fire may not only be driven in the desired direction, but the rate of burning may be regulated. The rate of burning may be easily regulated by placing pieces of bark or sods over the vents or by inserting the section of the limb of a tree, using the thing at hand and procured with the least exertion.

(4) Wood burns more rapidly when given a draft than where the fire is confined. The rate of burning may be regulated by the amount of air forced through the vents by the use of a blower.

(5) Much effective burning may be accomplished by boring a series of holes for vents, after which the fires may be started and allowed to burn by the natural drafts—burning trees into sections and the tops of large stumps, etc.

(6) Combining the methods of burning stumps and *logs by the use of a stump burner and boring intersecting holes and burning*, so that the fire is guided to the

best advantage and caused to burn briskly by a continual forced draft is both practicable and advisable.

Distilling stumps in place. According to *Engineering Record*, June 10, 1916, stumps in a timber country are not usually considered an asset, but Eastman, Gardiner & Company of Laurel, Miss., owners of much long-leaf pine timber land, have found a way to distill various pine oils direct from the stump. From an ordinary



Fig. 14. Distilling Stumps in Place

good-sized stump about 25 gal. of distillate are obtained by the hood-shaped apparatus shown in the accompanying photograph. After removing the water there remain about 17 gal. of heavy pine oil. The stump is converted into a fine grade of charcoal, very much like coke. It is destroyed far enough underground to permit plowing over it without further work. There is a cylinder inside the conical cover, and the intervening space is filled with pine knots for fuel. About four hours are required to destroy a stump, so the distillers handle two stumps per day.

A stump burner which requires no blower is described by E. Roy Allison in *Engineering Record*, March 31, 1917, as follows:

In contrast with the closed type of hood burner, this latest stump burner consists of a metal housing with various apertures for particular service, with smoke-pipe connection at the top. It is constructed in sections to provide for any class of service, covering both large and small stumps. By the use of movable draft pipes arranged around and near the base of the burner, it eliminates the necessity for any blower or other artificial draft device, the required draft being brought about by natural conditions and hood construction, and in a highly efficient manner for the service designed. While this burner operates more slowly through the use of natural draft, demanding greater periods of time for stump consumption, the operating cost is reduced to a minimum, the primary expense being that of labor and

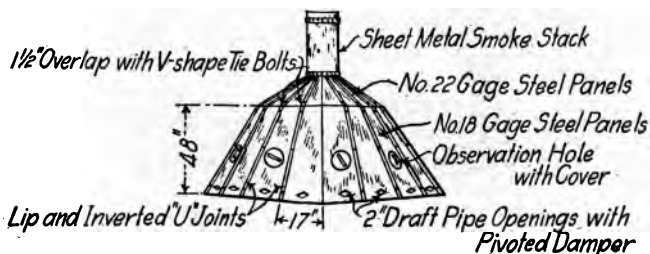

Fig. 14a. The Hubbard Stump Burner

attendance, which is low when a number of burners are in operation on the same land at the same time.

This burner, known as the Hubbard stump burner and produced at Seattle, consists of an adjustable steel hood of two principal sections to form a base and top, designed to be placed over the stump, or stumps, in operation. Each section is built up to any desired size by means of interchangeable panels, allowing the utmost facility in handling and erecting on the site. The lower section panels, when joined together, have a clear width of 17 in. at the base. Installed in position, using such *number of panels as is required*, they form a frustrum. *with the upper edge to serve as the support for the top section.* *This top section also forms a flatter frustrum,*

terminating with an opening 12 in. or less in diameter, depending on the number of panels used, and is equipped with a smokestack, as shown. Each panel is arranged for connection to the adjoining panel in the field with stove bolts or strong cotter pins.

Prior to operation, the stump, or stumps, to be burned are cleared away sufficiently of dirt and debris at the roots to allow the kindling of a good fire. After the erection of the hood over the area, the fire is started by using the observation openings in the lower panels, while the draft pipes to be employed are inserted in position to render the best possible effect of the forced draft. The draft increases as the temperature rises under the hood, being augmented by feeding logs to the fire, as needed, after kindling.

The draft tubes are pushed in from time to time as the roots of the stump are consumed, while the number of tubes with which the hood is provided allows for a full play of the fire. The volume of hot air in the hood produces a constant and forced draft through each tube—a heat, however, which is not intense enough to affect the sheet steel hood, as the air supply is limited at the roots.

Recent tests on Washington timber lands show that this type of stump burner will consume stumps from 3 to 5 ft. in diameter, together with roots within the range of the burner, in a period of 24 hours, while larger stumps from 6 to 7 ft. are burned in 30 or 40 hours. In connection with a low first cost and operating expense, this stump burner offers particularly effective service in the field, both in installation and in removal to adjacent sites.

CHAPTER VI

BLASTING

Blasting outfit and methods used in Wisconsin. Bulletin 216 of the University of Wisconsin, Agricultural Experiment Station, published in 1911 by J. F. Kadonsky, gives some valuable information on the use of explosives in clearing land, from which the following is taken.

Kinds of explosives. The common kinds of explosives used in Wisconsin and Minnesota are dynamite and virite. The dynamite ranges from 20 per cent to 60 per cent in strength but the most universally used is 40 per cent. The 60 per cent "straight" acts very rapidly with a shattering effect, while the 25 per cent "extra" acts comparatively slowly with a propelling force. Virite is only of one strength equal to 40 per cent dynamite, as determined in the field, but much slower in action. The higher the strength the speedier and more sensitive the dynamite. Those grades marked "extra" are slower in action and should be used where a propelling force is desired.

It is very important to have the different grades of dynamite where shattering and propelling forces are required. In raising a boulder or a stump, a slow propelling force is best, but for breaking rocks or stumps a speedy shattering force is necessary. Dynamite freezes easily and when in that condition should be handled very carefully. When it is left in the hot sun during the summer it is rendered much more sensitive and requires more precautions in working with it. The effects of the odor or contact with dynamite causes many operators to *become sick*. If a pair of canvas gloves is used in *handling the cartridges* they can be discarded when they

become saturated. . . Breathing the smoke or fumes should be entirely avoided.

[The reader is referred to Gillette's "Handbook of Rock Excavation" for methods of handling, storing, thawing and charging dynamite.]

Virite is comparatively more stable than dynamite. The latter can almost always be exploded by a ball from a rifle, while the virite would remain intact. Virite is



Fig. 15. A Handy Box for Carrying Explosives, Fuses and Caps. Compartments in One End Provide for the Caps and Fuses

put up in bulk or cartridge form and is non-freezing, and consequently can be used in the coldest climate without thawing. It has no odor which affects the operator as in case of dynamite, but the powder cannot be used in water unless confined in waterproof cartridges.

Blasting equipment and methods. The following is a list of equipment needed for blasting in the field: A supply box, auger, crowbar, shovel, wooden ramrod, and a cap-crimper. A supply box can be made on the farm by taking an empty dynamite box and placing a vertical partition across one end, leaving a space the width of a explosive cap box. At one end of this make a compa

ment that will just admit a box of caps. The remainder of this space can be divided equally by one-half inch cross pieces and each section labelled 18 inches, 20 inches, and 24 inches, respectively. The remainder of the box is used for explosives. Care should always be taken to keep the caps separated from the explosive. A wooden

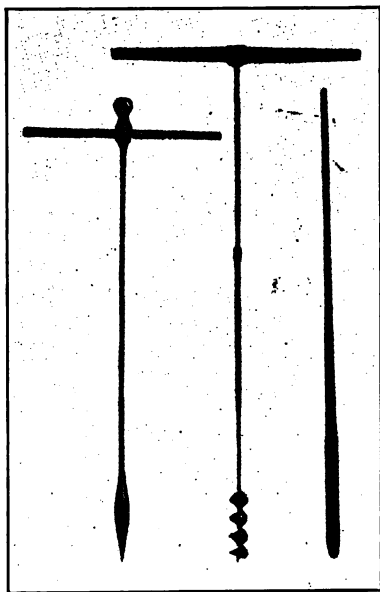

Fig. 16. Three Essential Tools for Preparing Holes Under Stumps for Blasting; Large Soil Auger in the Center, a Crowbar at the Right and a Pick at the Left for Opening a Hole Under the Stump. Each is an important Labor-saving device in Placing Explosives Properly

hoop may be nailed over this box for a handle so that it balances when filled with supplies. (See Fig. 15.)

A convenient auger is made by welding a long shank onto an ordinary 2-inch auger. Where the roots are not *too numerous* and admit a larger auger, it would be *advisable to use it*. A medium-sized tapering crowbar *should be used*. The large end should be drawn to an

edge, and the other end, to a blunt point. The ramrod can be made from an ordinary broom handle and should be at least $3\frac{1}{2}$ ft. long. These tools are shown in Figure 16. A round-pointed shovel is best for removing the soil from the roots when loading and in filling the hole when tamping the charge. A long tin funnel should be used to pour the virite, when in bulk, under the stump.

For making holes in the dynamite to receive the cap, a tapering hardwood stick just a trifle smaller than the diameter of the cap can be used. Attach this stick to a cord fastened to a trousers' button where it will not be lost. Where the stumps are of uniform diameter it is well to prepare the fuse of certain lengths before going into the field. Cut the fuse with a hand-ax by laying it on a block on which a board is nailed horizontally and marked the desired lengths.

Carry also a roll of fuse which may be cut in the field to meet exceptional cases. There are a good many different ways of handling this fuse. Some people blast with only about 6-inch fuse, no matter how long the hole is, by lighting the short fuse and dropping the dynamite on the rest of the charge, exploding without tamping. This method is very risky.

The end of the fuse should be cut square, not on a slant. If cut slantwise, the point, becoming dry and hard, is likely to explode the cap when inserted into it; or this point is likely to turn over in the cap and cause a misfire. The fuses are then inserted into the caps and crimped with a crimper. Care should be taken that each cap is free from any foreign matter, since this will serve as a protection to the fire from the fuse and cause a misfire. The fuse should not be inserted into the cap too far and should never touch the bottom, since this is very sensitive and may cause an explosion. When the end of the fuse enters the cap and is crimped, so that it just holds and withstands a reasonable amount of pulling during the process of tamping the charge, it is sufficient. The fulminate in the cap is so sensitive that it is exploded by the fire from the fuse when the end is nearly one inch outside the opening of the cap, if the fuse

directed into it. Do not expect the fuse to burn like a fire cracker fuse. It is lit as soon as it gives a little spit of fire in answer to the match, but the outside cover of the fuse does not burn. Always retreat at least 100 ft. after lighting the fuse, until the charge explodes. Instances have occurred where the fuse was lit in the morning and hung fire all forenoon and exploded about 11 o'clock.

In light sandy soil the gases tend to blow out on either side of the stump between the roots when the charge is deep, leaving the stump in place. This is due to the greater ease with which the force can escape at some distance below the base of the stump where there is a greater spread of roots than farther above.

Care should also be taken not to place the explosive too shallow. If the charge is not deep enough and the head of the stump is weak the result is that the top of the stump is blown off, cutting and leaving the roots above the plow line.

It is difficult to set any hard and fast rules regarding the depth at which the charge should be placed under the stump. The operator must use his judgment in each individual case, but place the explosive as shallow as possible, avoiding cutting off any part of the stump above the plow line. This will give the best and most economical results. As a rule it is best to place the explosive in a bulk form breaking up the cartridges, especially when blasting large stumps. The force then radiates equally from one central point and splits the stump into the maximum number of parts. When the charge is in a cylindrical form, most of the force acts at right angles to it and generally splits the stump into two parts.

Hints on placing charges. There are a few things that should be observed about loading to save time and get the best results. When the hole for the charge is large, it is well to take the powder out of the cartridge and tamp it well into a bulk form. The paper wrappers should also be included, since these, which are saturated with nitro-glycerin, are also explosive. The quickest and most satisfactory way is to cut the wrapper length-

wise into four parts with a sharp knife as shown in Fig. 17.

When pressing the cartridge into the hole, always use a wooden ramrod, never a metal crowbar, and press the cartridge hard enough to make it compact. The explosion will then be complete and effective.

When this cut cartridge reaches the bottom of the hole and is pressed with the ramrod it bulges and crumbles

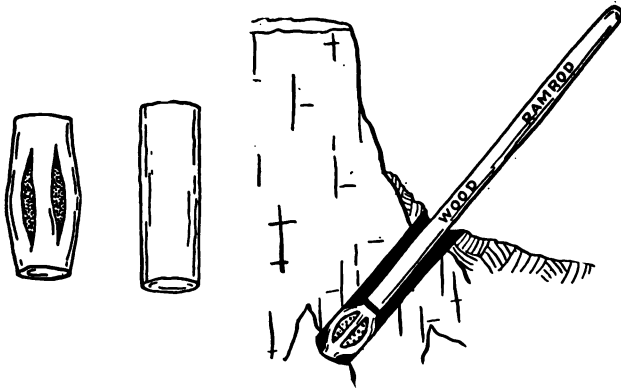

Fig. 17. Slitting the Wrapper to Enable the Charge to be Pressed Compactly in the Hole

into a mass. When placed in a cylindrical hole, the cut parts bulge so as to fill the opening completely, thus making the charge compact, which is desirable. (See Fig. 17.)

Into the last part of the charge, the fuse with cap crimped onto the end, should be placed. If an ordinary fuse is used, a very quick and satisfactory way is to hold the cartridge in the left hand and make a hole with a pointed stick slightly smaller than the diameter of the cap in the side near one end at an angle of 30 degrees. The cap is then pressed into it so that it is buried in the powder and the fuse bent back to form a sort of hook with the cap as a point. This is passed down the hole to the remainder of the charge and the fuse can stand a reasonable amount of pulling without coming out, b

rather tends to go farther into the cartridge. The cap on an electric fuse can be inserted in the same manner, but the wires should be looped around the cartridge.

Care should be exercised not to tamp the part containing the cap, but to press it gently. The other part of the charge must be tamped well if dynamite is used, but with virite, it must always be left in an absolutely loose form. The charge is generally tamped with soil, which is brought up with the tool in boring the hole, or with any loose soil which may be at hand. Always use a wooden ramrod in placing and tamping the explosives, *and never place any metallic tool down the hole near the charge under any circumstance.*

When the operator has had some experience and knows the approximate amount of explosive required for a stump, it is well to load a large number and fire them at one time. This saves time and miles of travel, if one blasts all day and fires each one after loading. A good way is to load for half a day and "fire" during the noon and evening hour, when the rest of the workmen are not present.

Relation of explosive to sub-soil. Each kind of soil requires a particular kind of explosive. It has been found that in the clay soils a slow propelling force is the most satisfactory, which is furnished in dynamite of 27 to 30 per cent strength. This explosive, acting slowly, removes the roots without snapping them off above the plow line, leaving the soil in a comparatively loose condition, which is very important. When a "speedy powder" is used, as 60 per cent strength, on the clay soil, it snaps many of the roots, leaving them above the plow line and packing the soil firmly, leaving a sort of basin.

For the light sandy soil where the footing is not good and there is chance for the gases to escape, a "speedy powder" should be used, equal to 60 per cent dynamite. The condition of the soil with respect to moisture regulates, to a great extent, the amount of explosive required *per stump*. Owing to a great variation in the structure of stumps, and soil condition, it is impossible to give any *definite information as to the amount of powder neces-*

sary to blast a stump of a given size. This must be regulated by the experience of the operator. Extremely loud reports and the throwing of the parts of the stump great distances is an indication of an excessive use of explosives. A deadened report following the explosion, the splitting and lifting of the stump just out of the ground shows the most economical use of the explosive.

Methods of firing charges. The most common way is to split the end of the fuse to expose the powder which is lit with a match. Some men place a pinch of dynamite on the end of the fuse. The quickest and most satisfactory way when matches are used is to thrust the head of a safety match, whose chemical part is just starting to burn, into the end of the fuse. This never fails to fire, no matter how much the wind blows. It is well to scratch the match on an adjacent root or the sole of the shoe, so the head of the match cannot burn long before being thrust into the fuse, which is very important in this method. Where a large number of stumps are to be fired at once, a live brand or an iron rod 1 in. thick and about 3 ft. long, heated in a burning rubbish pile in the field, is recommended.

The safest and perhaps the best means of firing is to use an electric blasting machine for that purpose. One electric blasting machine consists of several electric dry batteries arranged in a box for convenience in carrying, and connected with a switch which must be closed in order to fire the charge. It is fitted with screw binding posts for convenience in connecting the machine into the circuit with the powder. A number of stumps close together can be fired simultaneously. The cap of the electric fuse is placed in the cartridge in the same way as the cap on the time fuse, only the wire is looped about the cartridge. The wires running to the cap should be long enough so that they will project out of the hole when the charge is tamped.

Connect one of the cap-wires to a long wire running to the machine, 200 ft. away. Connect the other cap-wire to an insulated wire running to the next stump and so on through all convenient charges back to the blasting machine to complete the circuit. The method is ill-

trated in Fig. 18. The charges are fired by closing the switch.

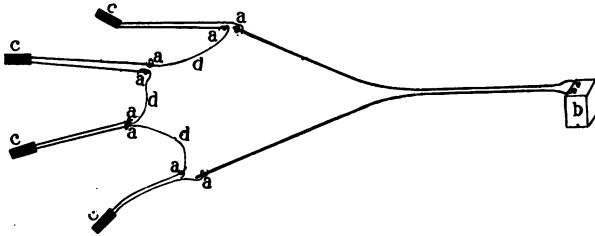

Fig. 18. Method of Blasting Several Stumps at Once; b Represents Electric Blasting Machine; c a Charge of a Stump Connected by the Cap-Wire into the Circuit at a; d Represents an Insulated Wire Connecting One Charge with Another

Care should always be taken to have the wires disconnected at the battery while preparing the charges. Electric firing has advantages over time-fuse in that ac-



Fig. 19. Du Pont Pocket Blasting Machine. Capacity, 4 Blasting Caps

cidents are less likely to occur, the chance for misfires is reduced, and there is a saving of time by blasting a number of stumps simultaneously. Often two or more adjacent charges must be fired at once to get the best results, which is possible only by the use of electricity.

Causes of misfires. Misfires are due principally to the presence of foreign material in the cap; pulling the fuse out of the cap; pulling the cap out of the powder; or to a defective fuse. Perhaps the most serious accidents occur when a time fuse burns to a certain point, and then, owing to some defect, burns very slowly for a

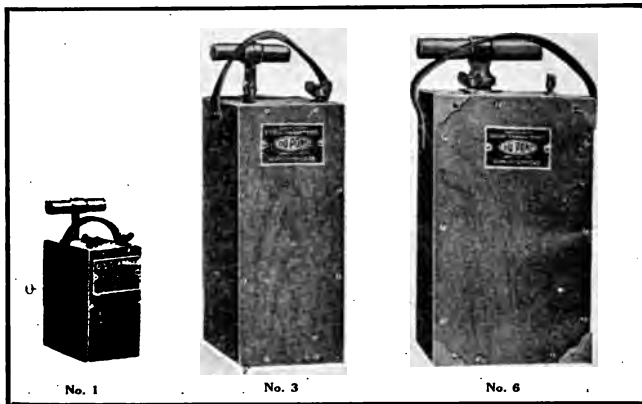

Fig. 20. Relative Sizes of Dupont Blasting Machines. Capacity 1 to 5, 30, and 150 Blasting Caps

few minutes. The operator after waiting for what he considers a long time, approaches the stump, when the explosion takes place, with serious results to himself.

A misfire should be left until one is absolutely positive that it will not explode. Do not go near it until the following day. Then it can be treated by making a hole or removing the tamping toward the charge carefully, but not bringing anything in contact with the explosive. A small charge is then placed near the first, which, upon exploding, generally sets off the first charge.

Placing the charge. The following is an abstract

the "Farmer's Handbook of Explosives," published by the Du Pont Powder Co.:

Root systems of the different forest trees are subject to a considerable number of variations, due to the class of tree, the soil and the depth to sheet water. Ordinarily, forest trees are divided according to their root systems into three classes. These are: Those having tap roots; those having no tap roots but only lateral fibrous roots; and those having both a small tap root and many fibrous roots. When trees that normally develop heavy tap roots are grown on soils where the ground water level is very near the surface, the tap root will be materially shortened or entirely wanting. Fibrous rooted trees growing in loose soils not troubled by bad drainage, may send heavy lateral roots to considerable depths. The highly resinous tap roots of such trees as the pine decay very slowly.

Several factors very materially influence the blasting of stumps, notably of which are:

The character of the root, whether tap or fibrous.

The nature of the soil with regard to the resistance it offers the explosive.

The state of preservation of the stump, whether sound or partially decayed.

Freshly cut or green stumps are much harder to blast than those from which the small fibrous roots and bark have decayed.

Tap-rooted stumps are easier to blast than fibrous-rooted ones. The semi-tap rooted ones are slightly more difficult to blast than the tap-rooted ones, but not so difficult as the fibrous-rooted ones.

In doing successful and economical stump blasting all depends on the proper location of the charge. For stumps of the tap root variety the best method is to bore into the tap root as shown in Fig. 21 (1). The usual method of doing this is to start a hole with a 1½-inch punch bar or dirt auger at a distance away from the center of the stump equal to its diameter, inclined at an *angle* of about 45 degrees towards the center until the *tap root is encountered*. The earth tool should then be *exchanged for a wood auger* and the hole continued to

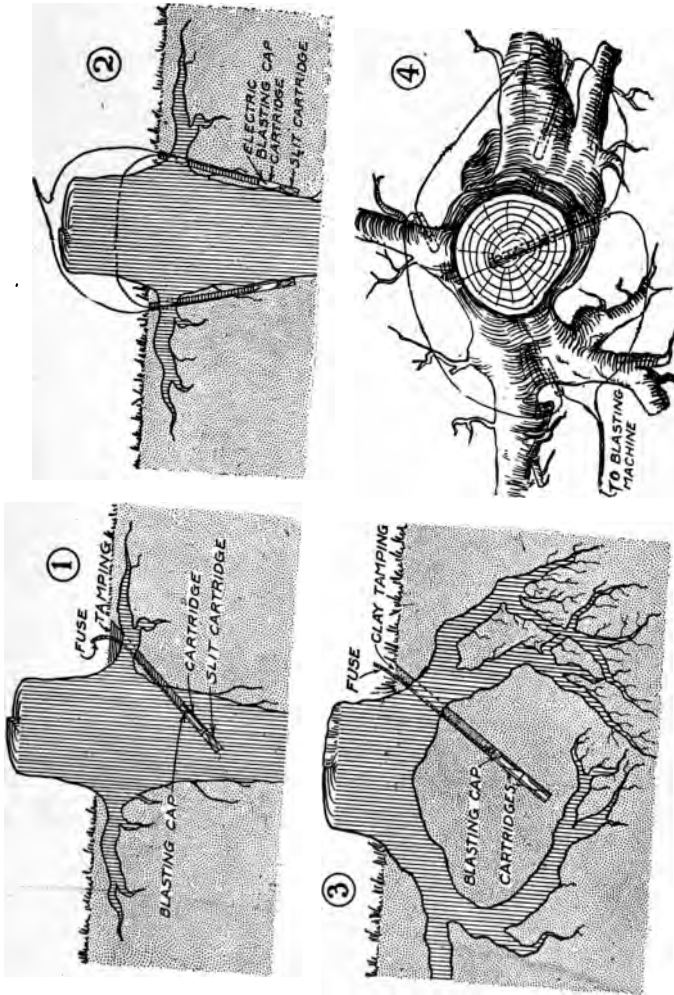

Fig. 21. Position of Charges for Various Types of Stumps.

three-fourths of the way through the tap root. Care should be exercised not to bore entirely through this, as in that case a good deal of the force of the dynamite when it explodes will be wasted in the soft ground beyond the tap root. The charge to be employed should vary from 1 to 6 cartridges of Red Cross Extra 40% Dynamite, the size of the charge varying in proportion to the size of the stump. The charge should be primed with cap and fuse and firmly packed—the tighter the better.

If you have a blasting machine and electric blasting caps and you wish to avoid the necessity of boring into tap root, we recommend placing the charges of dynamite firmly against the tap root as in Fig. 21 (2). Charges should be primed with No. 6 Du Pont electric blasting caps and firmly tamped.

When blasting out stumps of the semi-tap or lateral root variety, that is, stumps having both tap and lateral roots, the paramount idea is to remove not only the part of it that projects above the ground, but to cut off and displace the roots below plow level. It is therefore necessary to place the charge well down in a central position below the stump in order that the explosion may exercise an equal pressure on all the roots.

A good many beginners in trying to carry out this principle make the common mistake of calculating to get the bottom of the borehole under the center of the stump. As may be observed that point would be the ideal location for the charge, but it must be taken into consideration that if a charge of 3 cartridges is used in a 1½-inch borehole, this will occupy at least 20 inches of the length of same, thereby leaving very little space for thorough tamping.

Furthermore, the bulk of the charge would not be under the center of the stump and would have the tendency to blow out the loaded side only and in doing so it would probably remove only half of the stump, leaving the other half remaining in the ground, with practically *no soil* resistance to enable the blaster to put a fresh *charge on the opposite side.*

It is apparent that an effort should be made to locate

the center of the charge at a point beyond the center line of the stump, as shown in Fig. 21 (3). To accomplish this correctly, a 1½-inch diameter hole should be bored at an angle of about 45 degrees inclined towards the center of the stump. This hole should be started at a distance away from the center of the stump equal to its diameter, and should be of sufficient length so that the bottom of same will be past the center line of the stump. The primer should be made with cap and fuse.

Stumps having a large diameter can also be blasted out by the cap and fuse method with a single charge, by boring a hole past the center line and enlarging the end of the same with one-quarter of a cartridge of dynamite primed with cap and fuse. This small charge should be pressed down to the bottom of borehole and should not be tamped. *Under no consideration should the hole be charged until it has had time to cool off.* The best plan is to work on other stumps awhile to give the chamber ample time to cool.

We recommend, however, that large stumps be blasted electrically. This is done by boring auger holes either partly through or under the principal spreading roots and one deep hole placed under the center of stump. See Fig. 21 (4). All charges should be primed with No. 6 Du Pont electric blasting caps, wires of which should be connected together to form a circuit. The first and last wires remaining should be attached to the two leading wires which are connected to blasting machine. Although large stumps can be successfully blasted by the ordinary cap and fuse method, we recommend the electrical system, as there is an economy in dynamite and results are more satisfactory.

For cypress, willows or stumps in very soft soil the following method of blasting is recommended. Place three to six holes (according to size of stump) 12 to 18 ins. away from stump between lateral roots at an angle of about 75 degrees inclined towards center of same (Fig. 22). Each hole should be charged with one or more cartridges of Du Pont Straight NG (nitro-glycerin) 80%, primed with electric blasting cap and fired with blasting machine. By adopting this method, the stump will

split into six or seven pieces and all roots extracted, leaving a very slight indentation in ground.

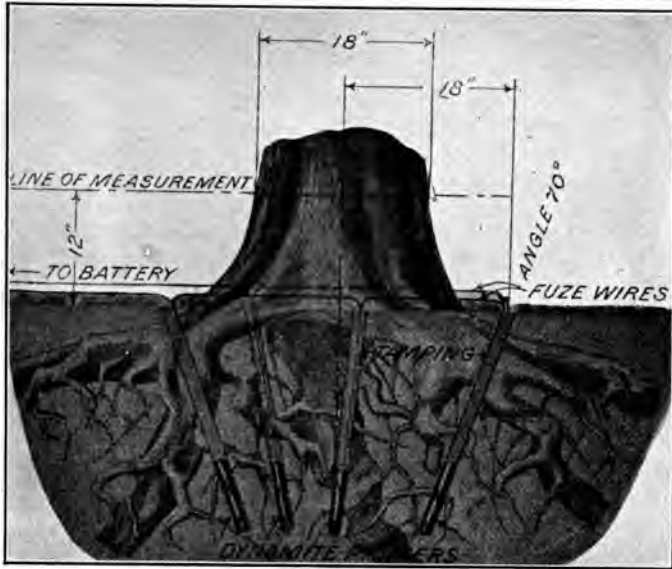

Fig. 22. Position of Charges for Large Stumps in Soft Ground

Amount of dynamite required. The following table will enable the beginner to obtain an idea of the number of Red Cross Extra 40% dynamite cartridges required for various size stumps. These figures are for old but sound stumps. Fresh, green stumps will require from one-half more to twice as much dynamite, and partly decayed stumps less than the amounts shown. After one has obtained a little efficiency in doing his work he will see that he can in the majority of cases considerably reduce these charges.

TABLE XI

| Diameter of Stumps in Inches | 12 | 18 | 24 | 30 | 36 | 42 | 48 | 54 | 60 | 66 | 72 |
|---|----|----|----|----|----|----|----|----|----|----|----|
| Approximate No. of $1\frac{1}{4}$ " x 8" Cartridges Red Cross 40% Extra Dynamite. | 1½ | 2 | 3 | 4 | 6 | 8 | 10 | 12 | 14 | 18 | 22 |

Twenty per cent Red Cross dynamite for stumping. In many soils, except loose sand or swamps, it is possible to blast out stumps more economically with 20% Red Cross dynamite than with the 40% strength. On the other hand in very loose or swampy soil it is sometimes advantageous to use Du Pont Straight Dynamite, 60% strength. The theory is this: Sand or muck will blow out much easier than the stump and offers little resistance. Hence, unless there is a good amount of sand or muck *between* the charge and the stump, the stump may not be blown out. But 60% Straight Dynamite is so fast and powerful that it blows the stump out before its power is lost through the sand or muck. On the other hand where the soil is loam or clay it offers good resistance and confines the force of 40% or 20% Red Cross Dynamite long enough to ensure getting out the stump.

Pacific Coast fir, pine and cedar stumps. In the States of Washington, Oregon and parts of California, where the rainfall is large and the ground in the forests is always damp, many of the trees grow to great size—many being 8 or 10 ft. in diameter. The roots of these trees usually spread out near the surface and do not grow deep into the ground as might be expected, tap roots being extremely rare.

The object when blasting these stumps is not to split them but to bring them out entire at one blast, with all of the roots possible, because if the charge of explosives is so gaged and located as to split the stump, it generally fails to bring out all of the pieces. As the principal object is to get out as much of the stump as possible at a minimum cost, it is better to blast it out first and then it can be easily split afterwards by means of a small quantity of dynamite exploded in auger holes.

The common rule in blasting these stumps is to use 1½ lbs. of Du Pont or Repauno Powder-Stumping L. F. per foot of diameter, with stumps up to 4 ft., when the subsoil is clay. For larger sizes from 2 to 2½ lbs. for each foot in diameter should be used. Stumps in gravelly or loose ground require one pound more for each foot in diameter.

The charge of explosives is best placed when there

16 to 24 ins. of earth between it and the bottom of the stump. This results in the force of the explosion radiating to all sides, lifting the stump clear of the ground, and bringing with it the greatest length of roots. If the charge is placed too close to the stump, the effect is to split it, leaving the roots to be dug out at extra labor and expense.

When these stumps are large the bottom of the borehole is "sprung" or chambered until it is so large that the increased charge required can be concentrated under the center of the stump. The chambering is done by exploding without tamping, first a half cartridge, then several successive charges of from one to five cartridges each in the bottom of the borehole. When the hole is large enough, it is given time to cool off and is then charged with the necessary quantity of Du Pont or Repauno Powder-Stumping L. F. to bring out the stump. *Under no consideration should the hole be charged until it has had time to cool off.*

The best plan is to work on other stumps awhile to give the chamber time to cool.

Redwood and big tree stumps. The way to estimate the quantity of Du Pont or Repauno Powder-Stumping L. F. necessary to blast out stumps larger than 8 ft. in diameter, is to square the largest diameter in feet, the result being approximately the number of pounds required. For example, if a stump is 8 ft. in diameter the charge of Du Pont or Repauno Powder-Stumping L. F. should be about the square of 8, or 64 lbs. Stumps less than 8 ft. in diameter require a little greater charge for their size than do the larger stumps, and the rule with them is to use as many pounds of Du Pont or Repauno Powder-Stumping L. F. as 8 times the largest diameter in feet. On this basis a stump 6 ft. in diameter would need about 48 lbs. of powder. However, the successful blasting of these large stumps depends greatly on the judgment of the blaster, and these rules can only be considered as a general guide. This can easily be understood when it is remembered that, owing to difference in soil or some peculiarity in the growth of the tree, it sometimes requires the same quantity of explosives prop-

erly to bring out a stump 6 ft. in diameter as it does another one 8 ft. in diameter.

In blasting these stumps a trench is dug large enough to permit placing the entire charge of explosives directly underneath the center of the stump. A little powder blasted in holes punched with a crowbar will prove of great assistance in digging this trench.

Bar for locating roots. Mr. J. R. Mattern, in a bulletin on clearing land of stumps, published by The Institute of Makers of Explosives, advises the use of a probing rod in locating roots, as follows:

The underground nature of each stump should be determined before placing charge or even making holes. You can do this partly by observing the roots that rise above the surface, but mostly by probing down among the roots with a $\frac{1}{4}$ -in. steel needle known as a probing rod. Every blaster should have one of these rods and should make use of it at each stump.

Amount of dynamite used in successful blasting. The following table taken from records of blasting in Minnesota, Pennsylvania, Oregon, Kentucky, Michigan and Florida is given by Mr. J. R. Mattern in a bulletin on clearing land of stumps, prepared for The Institute of Makers of Explosives. The stumps were blown out effectively and successfully and the figures should serve as a guide. The grades of dynamite used are not given.

TABLE XII

AMOUNT OF DYNAMITE USED IN SUCCESSFUL BLASTING

DEAD PINE STUMPS

| Diameter and soil | Sticks of $1\frac{1}{4}$ in. dynamite or powder |
|-------------------|---|
| 10 in., Clay | 1 |
| 12 " Sand | $1\frac{1}{2}$ |
| 12 " Loam | 1 |
| 12 " Clay | 1 |
| 14 " Clay | 2 |
| 16 " Clay | $1\frac{1}{2}$ |
| 18 " Sand | 3 |
| 18 " Loam | 2 |
| 18 " Clay | $1\frac{1}{2}$ |
| 20 " Sand | 7 |
| 20 " Clay | 4 |
| 24 " Loam | 5 |
| 24 " Sand | $5\frac{1}{2}$ |

CLEARING AND GRUBBING

| Diameter and soil | Sticks of 1¼ in. dynamite or powder |
|---------------------|-------------------------------------|
| 24 in., Loam | 4½ |
| 24 " Clay | 4 |
| 36 " Sand | 10 |
| 36 " Loam | 8½ |
| 36 " Clay | 7½ |
| 40 " Clay | 7 |
| 48 " Sand | 13 |
| 48 " Loam | 10 |
| 48 " Clay | 9 |
| 60 " Clay | 15 |
| GREEN PINE STUMPS | |
| 15 in., Loam | 4 |
| 24 " Sand | 10 |
| DEAD OAK STUMPS | |
| 8 in., Sand | 1½ |
| 12 " Sand | 2 |
| 12 " Loam | 1½ |
| 15 " Loam | 1½ |
| 16 " Clay | 1½ |
| 18 " Loam | 3 |
| 20 " Loam | 3½ |
| 24 " Clay | 3 |
| 26 " Clay | 2 |
| 27 " Sand | 5 |
| 27 " Loam | 4½ |
| 30 " Clay | 4½ |
| 30 " Sand | 6 |
| 34 " Clay | 4½ |
| 38 " Clay | 5½ |
| GREEN OAK STUMPS | |
| 16 in., Clay | 3 |
| DEAD FIR STUMPS | |
| 30 in., Loam | 10 |
| 36 " Clay | 12 |
| 48 " Loam | 26 |
| 72 " Clay | 36 |
| GREEN FIR STUMPS | |
| 40 in., Loam | 20 |
| GREEN SPRUCE STUMPS | |
| 60 in., Sand | 32 |
| DEAD HEMLOCK STUMPS | |
| 15 in., Sand | 2 |
| DEAD WALNUT STUMPS | |
| 10 in., Loam | 1 |
| GREEN GUM STUMPS | |
| 15 in., Clay | 3½ |

DEAD GUM STUMPS

| Diameter and soil | Sticks of 1¼ in. dynamite or powder |
|-------------------|-------------------------------------|
| 24 in., Sand | 4 |

GREEN BLACK GUM STUMPS

| | |
|--------------|----|
| 16 in., Sand | 5½ |
|--------------|----|

GREEN SUGAR MAPLE STUMPS

| | |
|--------------|----|
| 16 in., Sand | 5½ |
|--------------|----|

DEAD SNAG

| | |
|--------------|----|
| 20 in., Sand | 4½ |
|--------------|----|

TAP-ROOT PINE (CHARGE IN WOOD)

| | |
|-------------|----|
| 6 in., Sand | ½ |
| 8 " Sand | ¾ |
| 10 " Sand | 1 |
| 12 " Sand | 1½ |
| 15 " Sand | 2 |
| 18 " Sand | 2½ |

TAP-ROOT PINE (CHARGE AGAINST WOOD)

| | |
|-----------|----|
| 6 " Sand | 1 |
| 8 " Sand | 1½ |
| 12 " Sand | 3 |
| 15 " Sand | 4 |
| 18 " Sand | 5 |

To blast out standing trees without first cutting them down, use about 20% more explosive than you would for the stumps. It is better to blast big trees with several charges, firing them electrically.

Power driven outfit for boring stumps for blasting.

The following is from Farmer's Bulletin 600, by Harry Thompson, U. S. Dept. of Agriculture. In using explosives to blast stumps from the ground in order to prepare it for farming, it is comparatively easy to place the charge under a stump having a semi-tap root or a lateral system of rooting by boring or digging a hole in the earth to a point under the center of resistance and deep enough to give the desired effect.

Placing the charge. When clearing land where most of the stumps are tap-rooted, as in the longleaf-pine regions of the South, it has been found impracticable to place the charge in the earth outside of the stump, as this practice, because of the small size of the lateral roots, usually results in blowing the dirt away from one side

and only cracking and slightly loosening the stump.

To get the best results when blasting these stumps, the charge must be placed within the tap root. To do this, a hole of sufficient size and deep enough to place the explosive at the center must be bored into the stump. The hole should be bored so deep that the center of the charge will be at or near the center of the tap root.

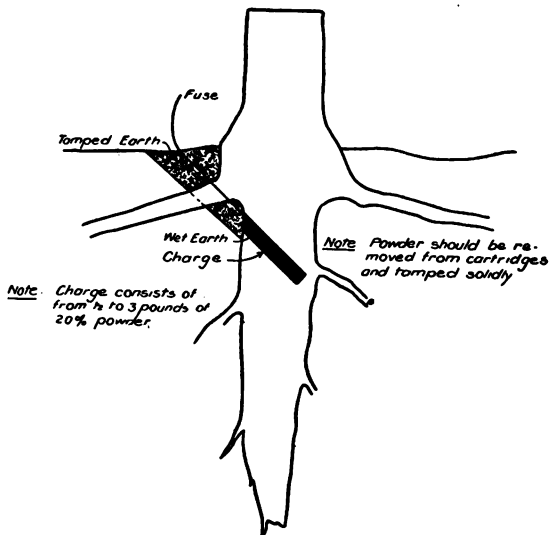

Fig. 23. Diagram Showing a Section of a Tap-Rooted Stump and a Charge in Position for Blasting

The hole should be started into the stump from 6 to 10 ins. below the surface and should slant downward at an angle of about 45 degrees. When stumps are blasted in this manner most of them will be broken off below the plow line (Fig. 23). Boring these holes by hand with a 1 $\frac{1}{4}$ -inch or 1 $\frac{1}{2}$ -inch auger is heavy work and in some cases will require two men when a ship auger is used.

Power outfit for boring stumps. Several turpentine companies who are using the stumps of the longleaf pine for distillation purposes have assembled outfits for bor-

ing these holes by means of electric drills, with power supplied by a dynamo run by a gasoline engine and mounted upon a wagon.

The outfit consists of the following: One 5-horsepower horizontal gasoline engine, one 3-kilowatt dynamo, all mounted on skids or a wagon and drawn by a team; two electric drills using 1½-inch augers of the required



Fig. 24. Boring a Long-Leaf Pine Stump with an Electric Drill

length (Fig. 24), together with the necessary cables for connecting. Augers 30 ins. in length are commonly used, although it is often desirable to drill to a greater depth. For this purpose a supply of augers 4 ft. in length is kept on hand. The longer augers break more frequently than the shorter ones.

It requires a crew of six to run this boring machine, as follows: An engineer and driver, four drill men (two for each drill), and a cable man or boy.

Method of operating. After the engine and dynamo have been securely mounted upon skids or a wagon,

outfit is taken to the stump field, the engine is started by the engineer, and the drills are supplied with current from the dynamo. Each drill is operated by two men and can be used on opposite sides of the outfit for a distance of about 100 ft. The cable boy keeps the cables from fouling on the stumps, logs and underbrush. He also keeps them from kinking, which would cause the copper wires to break.

When the hole is bored to the desired depth (see Fig. 23), the drill is removed and a handful of chips put upon the top of the stump to show that it has been bored.

An outfit of this sort drilled 500 stumps a day on an average during the month of May, 1913. The average cost per stump for the holes drilled was slightly less than 3 cts. This cost takes into account repairs, depreciation, and interest, as well as operating expenses.

An outfit of this kind could be utilized for boring the stumps for burning.

Although the companies operating these machines do not usually attempt to blow the stumps from far enough below the ground surface for agricultural purposes, it is estimated that digging away the soil near the stump to permit boring from 6 to 10 ins. below the surface will not cost more than 2 cts. per stump.

Results obtained in a test. In a test conducted by one of the companies operating a boring outfit similar to the one described, the dirt was thrown away from one side of the stump to a depth of 12 ins. and the hole bored into the stump at least 10 ins. below the surface. Of the 100 stumps so blasted, 97 were broken off below plow depth. The roots of the remaining 3 stumps were easily cut out low enough to permit cultivation. Slightly less powder was used upon these stumps than where the holes were bored at the surface of the ground. The total average cost for digging, boring and blasting was 22 cts. per stump. This cost does not include the disposal of the stumps, as the tops and roots were used for distillation purposes.

Average cost per stump for digging, boring and blasting:

| | |
|--------------------|----------------|
| Digging hole | \$0.020 |
| Boring stump | 0.030 |
| Cap and fuse | 0.025 |
| Powder | 0.145 |
| Total | \$0.220 |

Grade of powder to use. It has been found by those engaged in blasting the tap-rooted stumps that the lower grades of nitro-glycerin powders are most economical. The higher grades have more of a disruptive effect, tending to shatter the stump, but they do not throw it out of the ground as well as the lower grades of powder. There is very little difference in the effect secured by using 20 per cent and 25 per cent powder. The 20 per cent powder is cheaper and is generally considered the most suitable for stump-blasting purposes.

Cost of the boring outfit. The following prices for an electric stump-boring outfit are f. o. b. distribution point, and freight charges should be added to the place where used.

| | |
|------------------------------------|--------------|
| 5 horsepower gasoline engine | \$115 |
| 3 kilowatt dynamo | 185 |
| 2 electric drills | 80 |
| 6 augers, assorted lengths | 25 |
| 200 ft. of cable | 20 |
| Skids | 10 |
| Tools | 25 |
| Total | \$460 |

Cost of stumping. By using one or more electric boring outfits it is possible in a very short time to bore a large number of stumps for burning or blasting. The number of longleaf-pine stumps per acre that had to be bored in the tests varied from 20 to 70. As an average of about 500 stumps a day can be bored, from 10 to 20 acres can be covered in one day, the maximum number of borings being possible where the stumps are thickest.

The cost of stumping with this outfit and the use of dynamite will range from \$5 to \$18 per acre, provided the wood from the stumps and roots can be sold for enough to pay for their disposal after they blasted on

Miscellaneous cost data on blasting stumps. The following costs of blasting stumps are contained in 5 letters published by the Du Pont Powder Co.:

| | Cost per stump |
|--|----------------|
| (1) White oak stumps ranging from 2 to 3 ft. in diameter, 244 stumps per acre, 40% R. C. dynamite | \$0.15 |
| (2) Fir and cedar stumps 1.5 to 3 ft. in diameter, 40 in number, 40% R. C. dynamite | \$1.00 |
| (3) About 100 acres containing 10,000 pine, poplar, elm, oak and spruce stumps ranging from 10 in. to 4 ft. in size, 40% R. C. dynamite | \$0.10 |
| (4) About 12 acres containing 50 gum, hickory white and red oak stumps ranging from 12 in. to 36 in. in size | \$0.20 |
| (5) Pine stumps (154) blasted for the recovery of turpentine | \$0.33 |

Cost of clearing and grubbing a reservoir in Maryland. (*Engineering and Contracting*, Oct. 10, 1906.) On a reservoir site of 15 acres, all trees and brush were cleared off and stumps grubbed out at a cost of \$107 per acre. The trees were generally removed by blasting. Laborers were paid \$1.50 a day.

Methods and costs of clearing, hand grubbing and blasting. The following, by Daniel J. Hauer, is taken from *Engineering and Contracting*, Feb. 27, 1907: The work to be described was done by contract in 1893 for the purpose of opening up an avenue in the suburb of a large eastern city.

The area covered was nine acres, the trees being rather closely spaced, and the undergrowth, without being rank, was of long standing. The trees ranged in size from 6 ins. to 3 ft. in diameter, the average being about 20 ins. Everything smaller than 6 ins. was classed as "brush" and the stumps were grubbed with a mattock. The stumps of trees were blasted. The number of trees cut was over 1,100, while the actual number of stumps blasted was 1,212, or 135 per acre. The trees were first cut down, and the brush and leaf wood piled and burnt. Then the blasting commenced, while choppers sawed and split up the trees into cordwood and sawlogs. The timber consisted of oak, hickory, chestnut, and a scatter-

ing of a few other varieties. The work was done in the spring of the year, the weather being good.

The tools used for cutting and grubbing were as follows: Thirty-three axes, 29 mattocks, 30 shovels, one hatchet, one hand-saw, one 4-ft. cross-cut saw, two 6-ft. cross-cut saws, two files, two water buckets and two grindstones.

For blasting the following were used: One churn drill, one large auger and one bucket. These tools cost about \$80, which could be charged at a rate of \$9 per acre to the job.

Foremen were paid \$2.50 per 10-hour day and laborers, mostly Italians, were paid \$1.25. One foreman looked after the chopping and grubbing, consequently his salary is divided between these items, while a second foreman gave his time exclusively to the blasting.

Cost of clearing. The chopping down of the trees and brushes took about 13 days, the cost being as follows:

| | |
|----------------|----------|
| Foremen | \$ 20.00 |
| Laborers | 149.61 |
| | <hr/> |
| Total | \$169.61 |

This makes a cost of \$18.84 per acre. For eight days, as the above work was going on, another crew of men were piling and burning brush and grubbing the small stubs and stumps. This work was done at the following cost:

| | |
|----------------|----------|
| Foreman | \$ 10.00 |
| Laborers | 129.74 |
| | <hr/> |
| Total | \$139.74 |

Or a cost of \$15.53 per acre, and a total cost per acre for both chopping and cleaning up, of \$34.37. This can be divided as follows:

| | |
|----------------|---------|
| Foreman | \$ 3.33 |
| Laborers | \$31.04 |

When this much of the work was done a foreman and a small crew began the blasting of stumps, the cost of which is given below. At the same time the chopping

gang began to cut the tree trunks up into cordwood and sawlogs, while the cleaning gang was set to grubbing the roots and the remains of the stumps after the blasters. The sawlogs and cordwood were hauled away under another contract.

Cost of cordwood. The making of cordwood took 8 days and cost:

| | |
|----------------|---------|
| Foreman | \$10.00 |
| Laborers | 81.25 |
| | <hr/> |
| Total | 91.25 |

This was a cost of \$10.14 per acre. Unfortunately the wood was not corded up before being hauled away, so no accurate record was made of the amount, but there were between 175 and 200 cords, so that the cost of making cordwood was about \$0.50 per cord.

Cost of stumping. The blasting of the stumps took 25 days, the cost for labor, explosives, etc., being \$662.28, or a cost of \$73.59 per acre. These costs will be analyzed below.

The cost of grubbing the roots after blasting was as follows:

| | |
|----------------|----------|
| Foreman | \$ 40.00 |
| Laborers | 277.36 |
| | <hr/> |
| Total | \$317.36 |

This makes a cost per acre of \$35.26.

The cost per stump was as follows:

| | |
|--|---------|
| Foreman at \$2.50 a day | \$0.051 |
| Laborers at \$1.25 a day | 0.096 |
| Dynamite (40%) at 15 cts. per lb. | 0.156 |
| Judson powder at 10 cts. | 0.217 |
| Fuse (dbl. tape) at 49 cts. per 100 ft. | 0.020 |
| Caps at 75 cts. per 100 | 0.008 |
| | <hr/> |
| Total for blasting | \$0.548 |
| Grubbing | 0.262 |
| | <hr/> |
| Total per stump | \$0.810 |

Summary of cost per acre. From the above we obtain the total cost per acre for the 9 acres:

| | Per acre |
|-------------------------------|----------|
| Chopping | \$ 18.84 |
| Grubbing and clearing | 15.53 |
| Making cord wood | 10.14 |
| Blasting | 73.73 |
| Grubbing after blasting | 35.26 |
| Grinding axes | 0.65 |
| Tools | 9.00 |
| | <hr/> |
| Total | \$163.25 |

Dynamite, 40 per cent strength, and Judson or Contractors' powder were used as explosives, some of each being placed in the same hole. The stumps were not so large, except in a few cases, that one charge placed under it, by churning a hole with the drill and auger beneath the stump and then loading it, did not either blow the stump out or shatter it so that the grubbers were able to handle it. For a week only dynamite was used, and although some of the stumps blasted at that time were among the smallest, yet the blasting was done at less cost than when the two explosives were used.

Method and cost of blasting 3,500 stumps on Long Island. (*Engineering and Contracting*, May 13, 1908.) The Long Island R. R. bought a tract of land, in 1905, in Suffolk county on Long Island, in order to carry on experimental agricultural work. The tract was situated in the waste lands of the island and the first work to be done was to clear it of timber. A force of men was put to work cutting down the trees and undergrowth, and this work was followed by the stump blasting.

The blasting crew consisted of two men only, except for the three last days of the work, when a third man was employed to hasten the finishing of the job. The work was done during the latter part of the summer and the fall of the year, good weather prevailing most of the time.

One man employed was accustomed to handling explosives and had had experience in blasting stumps. He was paid \$3.50 for a 10-hour day. The second man was a common laborer and was paid \$1.50 per day. The third man, used for three days, also had handled explosives. He was paid \$3 per day.

In all 10 acres of land were cleared. The blasting gang made the hole under the stump and charged it, setting off the charge, but the work of cleaning up after the blast was done by other men. The stumps were mainly white oak and chestnut, varying in size from 18 ins. to $7\frac{1}{2}$ ft. in diameter. Many of the stumps ran from 4 to $4\frac{1}{2}$ ft. in diameter. Each acre of ground was measured off and a careful record kept of the number of stumps blown on each acre.

The following table shows the number of stumps blasted and the amount of dynamite used:

| Acre No. | Number Stumps | Lbs. Dynamite |
|-------------|------------------|------------------|
| 1 | 293 | 145 |
| 2 | 310 | 152 |
| 3 | 301 | 169 |
| 4 | 270 | 150 |
| 5 | 280 | 211 |
| 6 | 305 | 191 |
| 7 | 285 | 178 |
| 8 | 337 | 188 |
| 9 | 334 | 198 |
| 10 | 797 | 446 |
| Total | 3512 | 2031 |

The soil was a light loam with sand or gravel underlying it. Naturally the amounts of dynamite used per stump varied with the size of the stump. Small stumps up to 4 ft. in diameter needed $\frac{1}{2}$ lb. of dynamite. Stumps from 4 to 6 ft. in diameter needed from 1 to 3 lbs., while the largest stumps, measuring from 6 to 8 ft. in diameter needed from 3 to 4 lbs. of dynamite. The largest stump blown was a chestnut $7\frac{1}{2}$ ft. in diameter which took $3\frac{1}{2}$ lbs. of dynamite. It will be noticed that the average per stump was not quite 0.6 lb. All the dynamite used was 40%.

In blasting the stumps the helper made a hole with an auger or bar under the stump, so the charge would be close up to the stump and near the center. The dynamiter prepared a large number of cartridges with fuse and caps in them in advance, so that when a number of holes had been made, all he had to do was to place the

charge and tamp up the hole. Double tape fuse was used to put off the blast. The fuse was cut to lengths to explode the load within a given number of seconds, just enough time being allowed for a man to run to a safe distance. For most of the stumps, fuse a foot and a half in length was used, and when the end was split to allow of easy lighting, it took 30 seconds for this fuse to burn to the charge, hence this was known as a "30 second length." Care was taken to use enough dynamite to blow out the entire stump, but not to waste the explosives. Small stumps were blown out whole, but the larger ones were split up by the blast so they could be easily handled.

The number of stumps blasted per day varied somewhat, according to the size of the stumps and the difficulties encountered. The best day's work for two men was 110 stumps, while on other days they did 97, 60, and 99, the average being 84 for two men, for the job. On one day that three men worked 160 stumps were blasted. In clearing an adjoining piece of land one man by himself blasted in one day 100 stumps, but he had prepared the charges the day previous. The cost of blasting the stumps for the 10 acres was:

| | |
|--|----------|
| Labor— | |
| 1 man, 40 days, at \$3.50 | \$140.00 |
| 1 man, 40 days, at \$1.50 | 60.00 |
| 1 man, 3 days, at \$3.00 | 9.00 |
| 2,031 lbs. 40% dynamite at 15 cts. | 304.65 |
| 3,600 caps at 75 cts. per 100 | 27.00 |
| 7,000 ft. D. T. Fuse at 45 cts. per 100 .. | 31.50 |
| | <hr/> |
| Total | \$572.15 |

This gives a cost per stump of the following:

| | |
|----------------|---------|
| Labor | \$0.059 |
| Dynamite | 0.086 |
| Caps | 0.008 |
| Fuse | 0.009 |
| | <hr/> |
| Total | \$0.162 |

The cost per acre was \$57.22.
 This work was done under the direction of Mr. H

Fullerton, special agent of the Long Island R. R. Co.

Method and cost of blasting 1,100 stumps in New Jersey. (*Engineering and Contracting*, June 3, 1908.)

In grubbing stumps from land, one of the most economic methods is by blasting, provided care and judgment are shown in the use of explosives. The tendency seems to be to use a larger amount of explosives than is necessary. Then, too, different kinds of explosives are sometimes used in the same charge, such as dynamite and Judson powder. This should not be done. But one kind of powder should be used in a hole. For small and medium sized stumps dynamite will give the best results, but Judson powder will do efficient work on large stumps, and, at times for very large stumps, black powder is the cheapest to use.

The charge should be placed well up under the stump and as near the center of the stump as possible. A bar is generally the best tool for making the hole. When only one charge is placed under the stump it is more economical to use fuse and a cap. It is possible in stump blasting to use single tape fuse, but, if the ground is very wet, it may misfire. Under such conditions it is better to use double tape fuse. When several charges are placed under one stump, it is always advisable to use electrical exploders, so that the charges will be exploded simultaneously. For a single charge, electrical fuses are too expensive.

In the job, the cost of which we give below, dynamite was used exclusively, and caps and fuse were used for most stumps, but electrical exploders were used on some, as several charges were placed under some of the largest stumps. There were 1,100 stumps blasted from 4 acres of land, the job being in eastern New Jersey. The trees had been cut about 2 years, and were mostly white oak and hickory. They varied in size from 4 ins. to 6 ft., the average size of the 1,100 stumps being about 15 ins. in diameter.

The dynamite used was 40 per cent. The ground was full of large boulders, and more fuse (single tape) was *used than would have been required if the ground had not been full of stones.* The long fuse was necessary in

order to allow the men time to get away from the flying pieces of stone. Two men only were employed. One man handled the dynamite and the other prepared the holes. These men did nothing towards cleaning up the stumps after they were blasted.

The cost of the labor was as follows:

| | |
|------------------------------------|----------------|
| Dynamiter, 19 days at \$3.50 | \$66.50 |
| Helper, 19 days at \$1.50 | 28.50 |
| Total | <u>\$95.00</u> |

The cost of the explosives was:

| | |
|---|-----------------|
| 850 lbs. dynamite, at 15 cts. | \$127.50 |
| 1,300 caps at 75 cts. for 100 | 9.75 |
| 1,300 ft. S. T. fuse, at 45 cts. per 100 | 5.85 |
| 300 short electrical exploders, at 6 cts. .. | 18.00 |
| Total | <u>\$161.10</u> |

The total cost for the 4 acres was \$256.10, giving a cost per acre of \$64.02.

The cost per stump was:

| | |
|-----------------|----------------|
| Labor | \$0.086 |
| Dynamite | 0.116 |
| Caps | 0.009 |
| Fuse | 0.005 |
| Exploders | 0.016 |
| Total | <u>\$0.232</u> |

The average amount of dynamite used per stump was 0.77 lb.

This is an economical job of blasting, both as to labor, costs and explosives.

The work was done under the direction of Mr. Oscar Kissam of Halesite, Long Island, N. Y.

Blasting stumps in Kentucky. Mr. George Roberts, in Bulletin 154 of the Kentucky Agricultural Experiment Station, gives some cost data on removing stumps by blasting, which is of special interest as an account was kept of the amount of explosive used on each stump.

In the following table is given the number, size and kind of stumps removed from the London, Ky., fire

together with the amount of dynamite and labor required. This field contained about 6 acres and had been cleared about 8 years, long enough, so that small stumps of 10 ins. and less could be broken out quite readily with an ax and grubbing hoe. Each stick of dynamite weighed $\frac{1}{2}$ lb.

TABLE XIII

| Size and Kind of Stump | Sticks Dynamite Used |
|------------------------|---------------------------|
| 12 in. dead oak | 2 |
| 16 " dead oak | 1½ |
| 15 " dead oak | 1½ |
| 16 " dead pine | 1½ |
| 13 " dead oak | 1½ |
| 30 " dead oak | 5½ |
| 10 " dead oak | 1½ |
| 8 " dead oak | ½ |
| 12 " dead oak | 1½ |
| 13 " dead oak | 2 |
| 30 " dead oak | 4½ |
| 11 " dead oak | 1½ |
| 18 " dead oak | 3 |
| 12 " dead oak | 1½ |
| 20 " dead oak | 3½ |
| 34 " dead oak | 4½ |
| 9 " dead oak | 1½ |
| 14 " dead pine | 2 |
| 16 " green oak | 3 |
| 14 " dead oak | 2 |
| 12 " dead oak | 1½ |
| 30 " dead oak | 4½ |
| 24 " dead oak | 3 |
| 30 " dead oak | 1st shot 3½ 2nd shot 2 |
| 38 " dead oak | 5½ |
| 20 " dead oak | 3½ |
| 24 " dead oak | 3½ |
| 14 " green oak | 3 |
| 14 " green oak | 3 |
| 12 " dead oak | 1½ |
| 22 " dead oak | 4½ |
| 27 " dead oak | 4½ |
| 15 " dead oak | 2 |
| 14 " green oak | 4 |
| 30 " dead oak | 5 |
| 14 " dead oak | 2½ |
| 11 " dead oak | 1½ |
| 14 " dead oak | 2½ |
| 30 " dead oak | 6 |
| 18 " dead oak | 3½ |

| Size and Kind of Stump | Sticks Dynamite Used |
|------------------------|--------------------------|
| 20 in., dead snag * | 4½ |
| 8 " dead oak | 1 |
| 16 " dead oak | 3 |
| 16 " dead pine | 2½ |
| 27 " dead oak | 5 |
| 6 " dead oak | ½ |
| 8 " dead oak | 1 |
| 13 " dead oak | 2½ |
| 16 " dead oak | 3½ |
| 15 " dead oak | 2½ |
| 6 " dead oak | 1 |
| 10 " dead pine | 1½ |
| 15 " dead oak | 3 |
| 16 " dead oak | 3 |
| 24 " dead oak | 5 |
| 16 " green black gum | 5½ |
| 13 " dead oak | 2 |
| 8 " dead oak | 1 |
| 16 " dead oak | 2½ |
| 13 " dead oak | 1½ |
| 24 " dead gum | 1st shot 2 2nd shot 2 |
| 16 " dead oak | 1½ |
| 10 " dead oak | 1½ |
| 12 " dead oak | 1½ |
| 6 " dead oak | ½ |
| 8 " dead oak | 1 |
| 14 " dead oak | 2 |
| 16 " dead oak | 2½ |
| 12 " dead oak | 1 |
| 10 " dead pine | 1 |
| 16 " green sugar maple | 5½ |
| 12 " dead oak | 2½ |
| 12 " dead oak | 2 |
| 28 " dead oak | 1st shot 4 2nd shot 3 |
| 12 " dead oak | 1½ |
| 26 " dead oak | 2 |
| 18 " dead oak | 2 |
| 8 " dead oak | 1 |
| 16 " dead oak | 2½ |
| 15 " dead oak | 2 |
| 17 " dead oak | 2½ |
| 16 " dead oak | 2½ |
| 13 " dead oak | 2 |
| 10 " dead oak | 1 |
| 12 " dead oak | 2 |
| 16 " dead oak | 2½ |
| 12 " dead oak | 2 |
| 14 " dead oak | 2½ |

CLEARING AND GRUBBING

| Size and Kind of Stump | Sticks Dynamite Used |
|------------------------|----------------------|
| 8 in., dead oak | 1 |
| 8 " dead oak | 1 |
| 14 " dead oak | 2½ |
| 16 " dead oak | 2 |
| 12 " dead oak | 1½ |
| 8 " green oak | 2 |
| 16 " dead oak | 2 |
| 12 " dead oak | 1½ |
| 15 " green gum | 3½ |
| 15 " dead oak | 2½ |
| 16 " dead oak | 3 |
| 24 " dead oak | 5 |
| 18 " dead oak | 3 |
| 15 " dead oak | 3 |
| 16 " dead oak | 2½ |

* More dynamite is required to blow a tree or snag than to blow a stump of the same diameter, because of the greater weight to be lifted.

Average diameter of stumps, 16 inches.

Total number of sticks of dynamite required, 265.

Average number of sticks required per stump, 2.6.

Time required for one man, 5 days.

Average time required per stump, 30 minutes.

Summary:

| | |
|-------------------------------------|---------|
| 132.5 lbs. dynamite at 18 cts. | \$23.85 |
| Caps and fuse | 2.35 |
| 5 days' Labor at \$1.50 | 7.50 |

Total, 102 stumps at 33 cts. \$33.70

STUMPS BLOWN ON EXPERIMENT STATION FARM, LEXINGTON, KY.

| No. | Kind of Stump | Diameter Inches | Sticks Dynamite Used |
|-----|-------------------|--------------------|-------------------------|
| 1 | Green Hackberry | 20 | 5 |
| 2 | Green Hackberry | 10 | 5 |
| 3 | Green Hackberry | 7 | 6 |
| 4 | Dead Hackberry | 11 | 4 |
| 5 | Green Elm | 5 | 3 |
| 6 | Dead Walnut | 12 | 2 |
| 7 | Dead Walnut | 14 | 1½ |
| 8 | Green Cherry | 10 | 2½ |
| 9 | Green Maple | 12 | 1½ |
| 10 | Dead Osage Orange | 7 | 2 |
| 11 | Dead Osage Orange | 15 | 2½ |
| 12 | Dead Osage Orange | 13 | 2 |
| 13 | Dead Osage Orange | 11 | 2½ |
| 14 | Green Oak | 45 | 2½ |
| 15 | Green Oak | 48 | 25 |
| 16 | Green Oak | 43 | 24 |

It will be seen by referring to the foregoing table that it is considerably more expensive to blow green stumps than dead ones. While the lot is a miscellaneous one, and contains kinds of stumps that are not generally found on farms, it brings out plainly the fact that green stumps require a great deal more dynamite than dead ones. Also a great deal more labor is required because much time is consumed in cutting the green roots, both before and after the explosion.

The average diameter of the 9 green stumps in the table is 22 ins.; the number of sticks of dynamite required was 93; the time consumed in blowing them was 18½ hrs. for two men whose wages were \$2.75 per day; the fuse and caps cost 60 cts. Thus the total cost of blowing the stumps was \$14.06, or \$1.56 per stump.

The cost of blowing the 3 large green oak stumps was: Dynamite, caps and fuse \$6.70, and labor \$3.85, a total of \$10.55, or \$3.52 per stump of average diameter of 45 inches.

While these figures seem high, yet there is no other method by which they could be removed so cheaply.

The amount of dynamite required to blow stumps of the same kind in the same soil does not vary directly with the diameter, but more nearly with the square of the diameter, or, in other words, with the area of a cross section of the stump. The area of the cross section of a stump 48 ins. in diameter is 16 times as great as the area of a cross section of a stump 12 ins. in diameter. However, only judgment developed by experience can determine how much of the explosive shall be used in a given case.

The cost of blowing green stumps is from two and one-half to three times as great as for dead ones. While each individual will have to determine for himself whether he can afford the cost of removing the stumps, it may not be out of place to offer some suggestions.

Land would have to yield very high profits to pay for blowing green stumps. For ordinary land it seems that the most feasible plan is to plant it to some cultivated crop for say two years, during which the weeds and sprouts will be kept down. Sow to grass then, ?

pasture it for three or four years. Sheep are very effective in keeping down weeds and sprouts. What the animals do not keep down should be kept down with the hoe. When the small stumps are rotten enough to remove with grubbing hoe and ax, the larger ones may be blown at a cost that will not be prohibitive. One point seems clear, and that is, that when stumps are to be removed, the cheapest method is by the use of dynamite.

Grubbing reservoir site. The following is taken from *Engineering Record*, Jan. 15, 1916: As a preliminary to admitting water to the Kensico reservoir of the Catskill water supply system for New York City the contractor was required to clear the site of the huge basin, which will flood 2,218 acres of land, to a line 30 ft. outside of the flow line. How the work was done was described by George A. Winsor, section engineer of the Board of Water Supply, in a paper presented at the last convention of the New England Waterworks Association.

Under the specifications, grubbing included all designated areas within the 30-ft. margin of the reservoir, the reservoir bottom wherever the depth below the flow line is 35 ft. or less, and other areas wherever ordered. The grubbing consisted of the removal of all stumps and roots larger than 2 ins. in diameter to a depth of 6 ins. below the surface of the ground, and all holes left after grubbing the margins of the reservoir and its bottom to a depth of 10 ft. below the flow line had to be satisfactorily refilled. The principal natural timber growths around the basin consist of oak, maple, whitewood, birch, hickory, elm, locust, ash, dogwood, cedar, chestnut, and many fruit trees of different kinds. The chestnuts had been killed by the "bark disease."

Most of the clearing on the areas to be grubbed was done during the years 1910 and 1911, and the stumps of the trees were cut off close to the ground. For this reason the old method of pulling the stumps with a stump-puller of capstan type, pulling the stump with the tree as a lever, using a block and fall, or the use of the caterpillar traction engine as used at Ashokan reservoir, *were not adapted to the work at the Kensico reservoir.*

The grubbing was sublet by the reservoir contractor,

and a portion of it was again sublet. The method employed by the sub-contractors was as follows: All small stumps from 2 ins. to about 5 ins. in diameter were grubbed by hand, using axes and mattocks, and all sprouts were cut off of the larger stumps, which were then removed with the aid of an explosive. Sixty per cent dynamite was used most of the time, the quantity depending upon the size of the stump, variety of tree, and the quality of soil around the roots. Many areas covered with a thick growth of small locusts were encountered; these were pulled with a pair of horses or yoke of oxen with a chain hitched around the tree; usually a little grubbing was done on one side only. This proved to be a very effective and rapid method for removing these species of trees when not too large.

The contractor usually worked about three weeks after a monthly estimate on the grubbing and blasting, as he found it required the remainder of the month to clean up and burn the brush and stumps before his next succeeding monthly estimate. Work was carried on through the winter months with very little interruption, it being a very mild winter with but little snow; during the spring months, which were very dry, the contractor was forbidden to build fires because of the fire hazard to city property adjacent to the clearing limits. He continued with the grubbing operations and burned the stumps later when the grass was green and the weather suitable.

A daily record of the dynamite used was kept by the contractors for the estimate months, and the quantities used per acre have been computed as follows: Maximum dynamite used, September, 1914, 170 lbs. per acre; minimum dynamite used, January, 1915, 44 lbs. per acre; average dynamite used, for entire work, 95 lbs. per acre.

It was further demonstrated that it required less explosive to shatter a stump when the ground was frozen than when there was no frost. In the former case very little earth was disturbed by the blast; while in the latter case a large hole was made. A hole was made in the ground with an iron bar, and the explosive was placed under the stump; fuse exploders were always used.

The contract price for grubbing, which included r

filling holes, disposing of stumps and brush, and all expenses incidental to the work, was \$100 per acre. Mr. Winsor believes that the method employed in doing this work was the most economical and the best, under the circumstances. However, had it been possible to do the clearing and grubbing in one operation, the latter would have cost the contractor less, as there would be a considerable saving in both labor and explosive if one of the other mentioned methods had been employed.

Methods and costs of clearing sites for real estate development on Long Island. The following, by Myron H. Lewis, is taken from *Engineering and Contracting*, Feb. 19, 1913, and relates to the methods and cost of clearing about four acres of land: The land consisted of a heavily wooded tract, in which lumber had been cut a number of times in past years, leaving some very large stumps and second and third growth timber. There were in all about 2,400 trees and stumps of which about 650 were removed by blasting, the remaining being removed by grubbing and a stump-pulling machine.

The blasting required about 1,000 lbs. of dynamite, averaging about 2 lbs. of dynamite to each stump. The method pursued in the clearing was as follows: All the standing timber was first cut down and removed to adjoining property to be later cut up into cordwood. The smaller timber was then removed by grubbing and with the stump-pulling machine. While this work was in progress holes were being bored with crowbars and augers into the roots of the stump to receive the dynamite. Charges were placed, and after about 10 to 15 stumps were prepared, they were fired by means of an electric battery 300 ft. distant from the nearest charge. After the explosions, men were set to work immediately with grub-hoes to take out the roots which still remained clinging to the ground, although the stumps themselves were shattered into fragments. The removal of these remains proved costly on account of the spring and clinging nature of the roots.

The work complete, including cutting of the timber and taking out 2,400 stumps, cost about \$1,000, excluding insurance and profit. The soil was a very stiff clay,

all of which had to be loosened with a pick before it could be shoveled. The cost of removing stumps was somewhat less than 50 cts. per stump. Some of the largest stumps cost over \$2 apiece.

Cost of clearing land for a large estate on Long Island. The following, by A. S. Malcomson, is taken from *Engineering and Contracting*, March 5, 1913: The work was clearing land for a large estate at Oyster Bay, Long Island. The writer believes the information to be as accurate as is possible on this kind of work. The data have been compiled from a record kept daily of the amount of material used; number and general size of stumps, and time consumed, with a certain allowance made for lost time which occurs on all work. Fig. 25 shows the form of daily report made out by the blaster on the work.

The cost of this work was 46 cts. per stump, exclusive of overhead expenses, but this figure would perhaps be increased on jobs of less consequence when dynamite would be bought in smaller quantities. When this material was disposed of by the men connected with the estate, the ground was ready for cultivation. The following are the itemized expenses of the work:

| | |
|--|-------------------|
| Blaster and helper | \$ 140.00 |
| Two laborers, boring holes | 94.50 |
| Insurance | 21.50 |
| 5,200 lbs. 40% Red Cross dynamite at \$0.12½ ... | 650.00 |
| 1,150 caps at \$0.7225 per 100 | 8.30 |
| 2,800 ft. fuse at \$0.4185 per 100 ft. | 11.76 |
| 1,719 electric fuses at \$2.975 per 100 | 51.05 |
| Demonstration and supervision | 50.00 |
| Total | \$1,027.11 |

There were 277 clumps containing 812 stumps. There were 290 large single stumps and 695 small single stumps. This makes a total of 1,797 stumps. In addition 451 "miscellaneous blasts" were fired to split up butts, remove snags, "priming" or chambering, etc.

Cost of stumping in Minnesota. Mr. A. J. McGuire gives the following in Bulletin 134 of the University of Minnesota Agricultural Experiment Station: The

CLEARING AND GRUBBING

| Date.....1913 | | DAILY REPORT | | | | Order No. 857... | | | |
|---|--------------------|--------------|-----|----------------|---------------|--------------------------|------------------------------|------------------|-------------------|
| Smith & Malcomson, Inc., Freeport, L. I. | | | | | | | | | |
| REPORT NO..... | Pounds of Dynamite | | | Number of caps | Feet of fuse | Number of electric fuses | Number of stumps or low-buts | Number of clumps | Wire and supplies |
| | 25% | 40% | 60% | | | | | | |
| Priming clumps | | | | | | | | | |
| Finishing clumps | | | | | | | | | |
| Chumps | | | | | | | | | |
| Totals | | | | | | | | | |
| Priming stumps | | | | | | | | | |
| Finishing stumps | | | | | | | | | |
| High stumps | | | | | | | | | |
| Low stumps | | | | | | | | | |
| Small stumps | | | | | | | | | |
| Splitting butts | | | | | | | | | |
| Totals | | | | | | | | | |
| Boulders | | | | | | | | | |
| Miscellaneous | | | | | | | | | |
| Grand Totals | | | | | | | | | |
| Material on hand | | | | | | | | | Weather |
| Material received today | | | | | | | | | |
| Totals | | | | | | | | | Temperature: |
| Material used today | | | | | | | | | Remarks: |
| Balance on hand | | | | | | | | | |
| Estimate of material necessary for completion | | | | | | | | | |
| Time Record—Hours | D.W.N. | C. N. | | | Outside Help | | | | Remarks |
| Time blasting | | | | | | | | | |
| Special time (specify) | | | | | | | | | |
| Time allowed—not working | | | | | | | | | |
| Total | | | | | | | | | |
| Time not allowed (specify) | | | | | | | | | |
| Time on other orders | | | | | | | | | |
| Grand Total | | | | | | | | | |
| Use reverse side for Remarks or Communications. | | | | | Signed: | | | | |

Fig. 25. Form of Daily Report

stump is a better unit of cost than the acre. The stumps can be counted and a fairly accurate estimate of the cost per acre based upon this count. At the North Central Experiment Farm, three years after the trees were cut, stumps averaging 14.3 ins. in diameter required 1.35 lbs. of 25 and 40 per cent dynamite per stump. Jack-pine, poplar, Norway pine and white pine stumps were removed from medium sandy soil at an average cost of 25.5 cts. per stump. This cost per stump included the cost

of piling and burning all brush and down timber as well as the stumps. The 25 per cent dynamite costs \$11.50, and the 40 per cent dynamite, \$12.50 per hundred pounds. Labor was included at \$1.50 per day for the man employed and \$3 per day for a man and team and averaged 7.5 cts. per stump. The cost of the explosive, including fuse and caps, was 18 cts. per stump.

In another clearing on the same farm, poplar stumps 14.1 ins. in diameter were removed from a clay loam soil at a total cost of 18.4 cts. per stump. The labor cost was 5 cts. and the explosive 13.4 cts. per stump. An average of 0.93 lb. of 40 per cent dynamite per stump was used. There was practically no brush or down timber. The trees had been cut four years before the removal of the stumps. In a third clearing at this farm, 1.84 lbs. of 60 per cent dynamite per stump were used in removing mixed hardwood stumps averaging 18.7 ins. in diameter. Other stumps of the same kind and size in this field were removed with 1.74 lbs. of 27 per cent dynamite. The trees had been cut from two to three years before the removal of the stumps. The soil was a clay loam with a heavy clay subsoil.

In all these clearings, the main expenditure was for explosives. The minimum amount of labor is involved when explosives are used exclusively. If the clearings had been large, the use of the stump-puller with the explosives would have reduced the cost per acre. On the small number of acres actually cleared the total cost would not have been reduced by the aid of a stump-puller.

In these clearings the stumps were those of medium-sized trees cut about three years before this work was done. The work and expense on the three clearings are summarized by the following statement:

Total, 905 stumps (on 8.7 acres); average diameter, 16.6 ins. The trees has been cut 3 years before.

| | |
|-----------------------------------|--------------|
| 112 hrs. making holes | \$ 16.75 |
| 112 hrs. blasting | 16.75 |
| 145 hrs. piling and burning | 21.75 |
| 60 hrs. piling and burning | 9.00 |
| <i>Total labor</i> | <u>\$ 64</u> |

| | |
|---|----------|
| Explosive (1,017 lbs.), fuse, and caps | \$141.39 |
| Total labor and explosives | \$205.68 |
| Cost per acre | 23.64 |
| Cost per stump | 0.23 |
| Holes made per ten-hour day, one man | 89 |
| Stumps blasted per ten-hour day, one man | 89 |
| Blasted stumps piled and burned per ten-hour day, two men and team | 137 |

Costly highway clearing in dense forests is noted in *Engineering Record*, Jan. 2, 1915. In running lines for the new State highway between Portland, Ore., and Astoria, the surveyors had to note the position of trees with as much care as rock excavation is measured in ordinary location surveys. One of the 12-ft. stumps which was moved from the road shown required the use of 150 lbs. of 40 per cent dynamite and occupied the workmen for a week. To get it out of the way cost at least \$75, not including the expensive rock fill which had to be made in the hole it left.

The clearing cost on this work ranges from \$100 to \$200 per acre, and averages about \$150, while the grubbing charge is kept down, by carefully locating the line between trees, to \$1.50 per square rod. The width of slashing depends upon the amount of sun and wind that must be admitted to the road, and, therefore, indirectly upon the rainfall. Usually a 60-ft. right of way is slashed, but for this road a 40-ft. width was considered sufficient.

Clearing and grubbing from Portland toward the coast averages about \$2,000 per linear mile of road, and in some sections easily amounts to \$3,000 per mile. For the most part this is being built now as a good earth road, but later on it is intended to lay on it a 16-ft. pavement.

This division of the Oregon State highway work is under the supervision of L. Griswold, assistant highway engineer.

Stump removal investigation conducted by the University of Wisconsin. The following is given by Carl D. Livingston, in *Engineering and Contracting*, July 19,

1916: The land clearing special which has just completed a demonstration tour of Northern Wisconsin has established certain points regarding stump removal which are of interest to contractors who have to do clearing in ditch and railway grading work. The writer, who organized and managed the tour, made a special study of different methods employed by the various co-operators, including horse-power, hand-power and dynamite, each working separately as well as in combination with each other. The following points were established to be good practice in land clearing:

Where the stumps are large it was found that, by using one-third to one-fourth the amount of dynamite necessary to blast a stump entirely out of the ground, it was possible to crack it into several pieces so that they could be pulled. Stumps may be pulled easier and quicker when cracked. The hole left is not nearly so large as when either pulled whole or blown out entirely. The roots are cleaner, are easier to handle, dry quicker and are more easily burned.

On the loams and clays it was found that 20 per cent Red Cross dynamite would do the same work as 40 per cent at a saving of 25 per cent on the dynamite bill. On the lighter soils the 30 per cent grades did as good work as the high kinds and cost about 10 per cent less. Forty per cent grades on higher are only needed on dry sands.

Electrical blasting was found to be quicker to operate, and far more safe than the old cap and fuse method. By the use of a blasting machine many charges may be detonated at the same time, either under the same or different stumps. This method enables the charge to be placed where they are most needed. The holes left are usually smaller and the cost is not greater when the results are taken into consideration.

Stump pilers are necessary to efficient land clearing where mechanical pullers are used. When they are equipped with automatic tripping devices, piling may be done at the same time as the stumps are being burned. When stumps are dropped on a burning pile a more complete burn is secured; some dirt may be left on the

roots and they may be much greener and still burn. The jar of falling stumps is like continually poking a grate fire.

Though essentially a land clearing demonstration, exhibitions of ditch blowing with dynamite were given. Beyond all doubt, explosives are extremely valuable in certain kinds of ditching work. No matter how wet, brushy or stony the ditch line may be, if sticks of 60 per cent straight nitro-glycerine dynamite can be located within 18 ins. of each other in wet ground, a serviceable open ditch can be made by the detonation of only one cartridge.

CHAPTER VII

HAND, HORSE, AND POWER STUMP-PULLERS

Cost of stump-pullers, as given in Mr. R. T. Dana's Handbook of Construction Plant, is as follows: A one-horse operated machine suitable for pulling trees and stumps up to 8 ins. in diameter, fitted with two steel double power pulleys and 100 ft. of $\frac{5}{8}$ -in. cable, weighs 490 lbs., and costs \$40.

A two-horse machine with a listed capacity of 22 tons, with 100 ft. of $\frac{3}{4}$ -in. cable, weighs 475 lbs., and costs \$35. The same outfit with one steel double power pulley has a capacity of 44 tons, weighs 535 lbs., and costs \$45; with two pulleys it has a capacity of 66 tons, weighs 595 lbs., and costs \$50.

A machine with a capacity of 30 tons, with 210 ft. of $\frac{3}{4}$ -in. cable, weighs 775 lbs., and costs \$85; with one pulley, having a capacity of 60 tons, weighs 855 lbs., and costs \$90; with two pulleys, having a capacity of 90 tons, weighs 930 lbs., and costs \$110.

The pullers having 50-, 100- and 150-ton capacities with the outfits heretofore described, weigh respectively 1,160, 1,260 and 1,360 lbs., and cost \$120, \$145 and \$155.

The capacities and prices of the largest machines are as follows:

Capacity 63 tons, with 100 ft. $1\frac{1}{8}$ -in. cable, weight 1,450 lbs., price \$145; with 200-ft. cable, weight 1,650 lbs., price \$200.

Capacity 125 tons, with one pulley, 100 ft. $1\frac{1}{8}$ -in. cable, weight 1,600 lbs., price \$175; with 200 ft. of cable, weight 1,800 lbs., price \$225.

Capacity 185 tons, 2 pulleys, 120 ft. $1\frac{1}{8}$ -in. cable, weight 1,750 lbs., price \$200; with 220 ft. of cable, weight 1,950 lbs., price \$255.

For taking up the slack rope, cam take-ups are used

These cost from \$4.50 to \$25. Root and stump hooks cost from \$7 to \$12.

The largest sizes of these machines are often used to move houses and buildings.

Man-power stump-puller. (From Bulletin 163 of the University of Minnesota Agricultural Station by Mr. M. J. Thompson.) In 1914 several models of man-power pullers were tested. In operating these machines, two men can work to better advantage than one. Three men were employed, two at the bar and one at the stump. The latter used the ax and mattock, releasing the large roots in order to start the stump, and removing the dirt after pulling. One man could, of course, do all three things but at much greater expenditure of time and energy. The larger stumps were cracked with dynamite before pulling.

Three men were employed, although two men or one man could have done the work, but at great disadvantage. Dynamite was used only on the larger stumps and then only to split them. The size of the stumps was estimated, not measured, as in all other work. For the sake of convenience in comparing with other methods, it may be assumed that the average diameter was 12 ins. here. In the comparisons made, some qualifications are required. The dynamite charge is high, because the stumps were blasted green. The daily output per man and per machine was double for the horse-power machine, but it is only fair to say that the work was done so hastily by the demonstrators that it was much less complete and less satisfactory than with the man-power machine. Note that the total cost per stump is less for the man-power machine, as less dynamite was used. The labor cost is much higher.

Several man-power stump-pullers are on the market, many of them of the same type, best described by saying they are like a stretcher for woven wire. Several things may be said in their favor. For the man who is without sufficient means to purchase a team and dynamite, but is under the necessity of making an immediate clearing *and is obliged to capitalize his own labor in making a start, a man-power machine is very helpful. It works*

nicely where the growth has been very dense with a consequent tree diameter of from 6 to 8 ins.; in a sandy soil, with stumps 12 ins. and less in diameter; or in a locality where cheap, unskilled labor is available. It is suitable for low lands where the horse-power machines or dynamite can be used only with difficulty and where the water is near the surface of the ground, thus making a shallow root system. For trees over 12 ins. in diameter, varying, of course, with the species of tree, the stage of decay, and the type and condition of the soil, dynamite is either necessary or very helpful in supplementing the work of the hand-power puller.

However, horse labor is cheaper than man labor and explosive is usually cheaper than either. While the actual cost of removal is somewhat less in either case than with dynamite, the cost of piling is very much higher. Moreover the showing becomes still more favorable for dynamite a few years after the land has been cut over and the stumps have had time to decay.

No charge has been made for interest on investment, taxes, or depreciation in estimating the cost of clearing with the stump-puller, or for the greater cost of piling and burning. The man-power machine removes less dirt while the horse-power machine takes all the roots. If the land is left in meadow or pasture for several years following clearing and before cropping, the roots left by the small machine will cause little difficulty, as they are close to or below the plow line. The man-power machine represents a small investment and is used to advantage on a small clearing. The horse- or steam-power machine represents a greater investment and is suitable for larger clearings. The limitation in either case is the amount of dirt lifted and the difficulty of disposing of the unwieldy bulk of the stump without special contrivances, a situation much modified by the use of dynamite in connection with the machine.

TABLE XIV

| RESULT OF FOUR DAYS' WORK WITH MAN-POWER STUMP-PULLER | |
|---|--------|
| Men working | 3 |
| Cost of labor | \$8.75 |

| | |
|--|--------|
| Hours worked | 9 |
| Amount of dynamite used (pounds) | 5.2 |
| Cost of dynamite | \$0.67 |
| Total stumps pulled | 72 |
| Green stumps | 53 |
| Dry stumps | 19 |
| Ground diameter of stumps, estimated (inches) .. | 3-27 |
| Total cost per day, labor and dynamite | \$7.42 |
| Average time per stump (minutes) | 7.75 |
| Average man labor per stump (minutes) | 23.25 |
| Average labor cost per stump (cents) | 7.75 |
| Actual cost per stump (cents) * | 10.3 |

* For purposes of comparison, these figures are on a basis of 20 cents per hour, although at that time labor actually cost 22½ cents.

TABLE XV

MAN-POWER VS. HORSE-POWER AND DYNAMITE *

| | Man-power | | Dynamite |
|---|-----------|------------------------|----------|
| | Machine | Horse-power Machine | |
| Time required to pull stump (minutes) | 7.75 | 3.27 | |
| Time required to pull stump, man-power (minutes) | 23.25 | 9.81 | |
| Time required to blast (minutes) | | 5.23 | 5.23 |
| Time required to remove stump, horsepower (minutes) | | 6.04 | |
| Cost per stump, man labor (20 cents per hour) | \$0.0833 | \$0.0533 | \$0.029 |
| Cost per stump, horse labor (7.5 cents per hour) | | \$0.0081 | |
| Total labor cost per stump | \$0.0833 | \$0.06 | |
| Total cost per stump, labor and dynamite | \$0.0926 | \$0.12 | \$0.141† |
| Number of stumps removed per horse per day | | 91 | |
| Number of stumps removed per man per day | 24 | 61 | 70 |

* Table VI shows blasting cost only. Table XV includes blasting and pulling.

† See Table VI.

In spite of the cheapness and simplicity on the one hand and the immense power developed on the other, under the average farm conditions existing in the clay-soil regions of the lake states, no better system has been *devised than that which is being followed successfully by many, by which the land is cut over, seeded and pastured for several years.* The stumps are then blasted

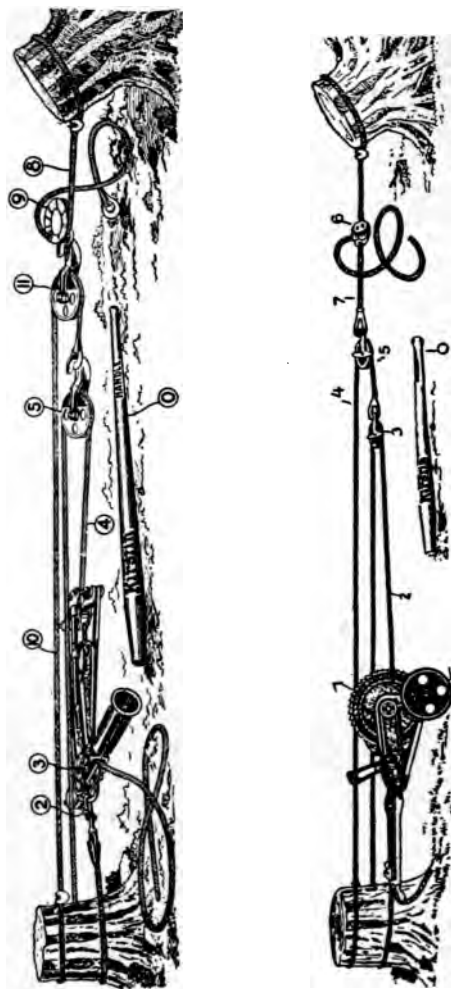

Fig. 26. Clutch and Drum Type Hand Stump Pullers. Made by
A. J. Kirstin Co., Escanaba, Mich.

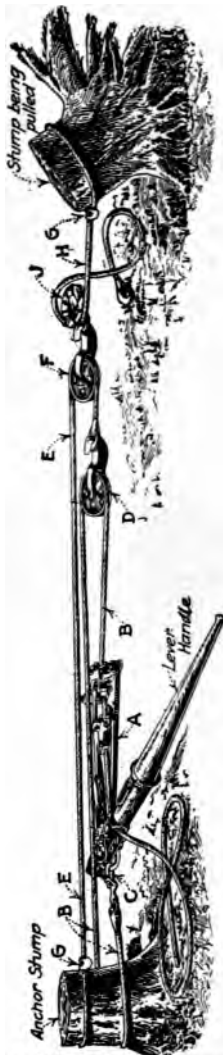

Fig. 27. Hand Stump Puller Operated by Clutches

and pulled and piled by horse-power, one man and a team doing the work.

Stump-pullers operated by hand and horse power.

(From *Engineering News*, Aug. 3, 1916.) The hand-power stump-puller shown in Fig. 27 is of the clutch type, and is manufactured by the A. J. Kirstin Co., of Escanaba, Mich. The pulling cable passes through a pair of clutch boxes operated by the movement of a long lever. As the lever is swung to and fro the clutches are gripped, moved and released alternately, so that the cable is held firmly by one clutch while the other is released and moved back for another grip and pull. The operation of the pulling set-up shown is as follows:

The puller *A* has one end attached to the cable *B* by means of a trip hook *C*. The cable is passed around an anchor stump, then to the block *D* and returns to pass through the clutches on the puller. A second cable *E* has a ring socket at one end which is hooked to the block *D*; it passes through a second block *F* and is then led to the anchor stump, to which it is secured by looping under a hook *G* on the end of the cable. A third cable

Z with a hook at one end and ring socket at the other is looped around the stump which is to be removed and

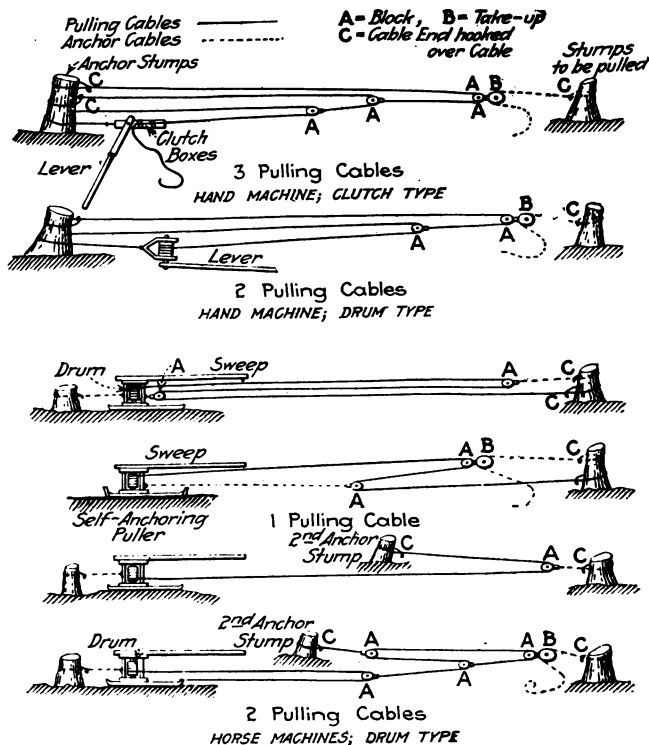

Fig. 28. Arrangements of Outfits and Rigging for Stump Pullers

secured by its hook, in the same way as at *G*. Its free end is passed around a take-up or cable-shortening device *J*, which is hooked to the second block *F*, and provides for taking up all slack between the block and the stump.

For heavier pulls, a third cable and block, similar to *EF*, may be used, with the take-up hooked to this block, as shown in the top diagram of Fig. 28. For comparatively light pulls, only the first block and the two cables *B* and *H* are used, the latter being connected to the block *D* either directly or through the take-up.

Other hand-operated stump-pullers are of the dr

type. One of these is the "K" device manufactured by Walter J. Fitzpatrick, 182 Fifth St., San Francisco, Calif. In this the cable is wound upon a small drum mounted in a frame and driven by pawl and ratchet gear by means of a long lever handle. From the drum the cable is led through a block and then returns, passing around the anchor stump and having its end attached to the frame carrying the drum. This arrangement is shown in the second diagram in Fig. 28.

Horse-operated stump-pullers are drum machines,

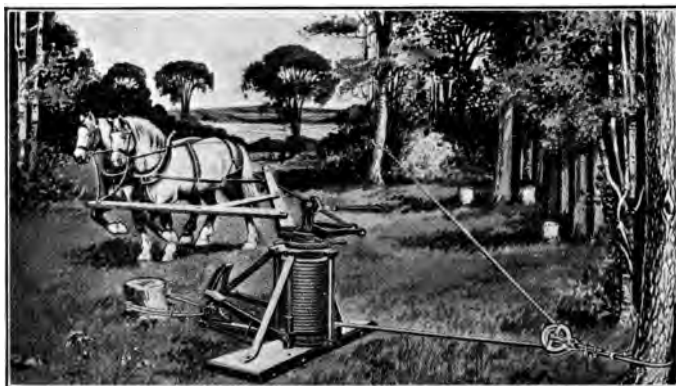

Fig. 29. Capstan Horse-Power Puller Made by Faultless Stump Puller Co., Cresco, Iowa

having the drum mounted upon skids or a truck and driven by means of one or two sweeps to which horses or teams are hitched. The frame carrying the drum may be hitched to an anchor stump, or secured by embedding its sills in the ground and driving heavy stakes at the ends. Fig. 29 shows an outfit by the Faultless Stump Puller Co., of Cresco, Iowa. Similar machines are made by numerous makers, each having its own special features.

The arrangement of the cable rigging is adapted to the power required, and some typical arrangements are shown in Fig. 28. Power is multiplied by attaching additional lines and blocks as indicated. When not re-

quired for this purpose, these extra parts may be used as snatchblocks to guide the main cable clear of obstructions or to keep it down near the ground so that the horses can step over it.

Various special devices are used in stump-pulling work. When stumps are small or too short and rotten to hold the cable loop or snare, a steel stump hook or root plow is used. This is of V-shape, with one leg horizontal and hitched to the cable; the other leg is inclined and ends either in a heavy point or in a broad-forked end to engage the stump or root. Handles on the back enable a man to guide the plow into position as it engages the stump. There are also root hooks (like ice tongs) for pulling short and rotten stumps.

For clearing brush, there is a device having three or four short ropes or chains attached to an iron head which is hooked to the pulling cable. These ropes are looped around the stumps or trunks, and enable a large amount of the brush to be removed at each pull. Where the stumps are to be piled for burning, a "skidder" or light portable derrick on skids is used.

Horse-power stump-pullers. The following is taken from *Engineering and Contracting*, March 25, 1908: A horse-power stump-puller is usually a capstan or whim-gin, Figs. 30 and 31. The machine is set up at a convenient level spot, and wire cables are fastened to the stump to be pulled. The team is started and as they circle around the puller, the cable is wound up on the drum of the machine, causing such a gradual and powerful strain on the stump that it is dislodged from the ground.

There are a number of firms manufacturing stump-pullers and each make varies but little from the others in general design. Most manufacturers are now making grooved drums on their machines, as this prevents the steel rope from cutting against itself as it winds on the drum, and from being pressed out of shape. Pullers made of steel instead of iron are much stronger for the same weight, which is an advantage when the machine has to be moved frequently.

Some of the pullers are mounted on small bases, &

these generally have to be anchored by means of a cable or chain to an adjoining stump or tree, (see Fig. 30). Some of these machines have a large hook on the side to be used in anchoring.

Fig. 31 shows a machine with a large base. This machine is not ordinarily anchored, but, if much work is to be done at one place, and especially if the stumps are large green ones, it is well to anchor both styles of bases, by driving large forked stubs in the ground on all sides of the puller, thus holding it to the ground and in place.

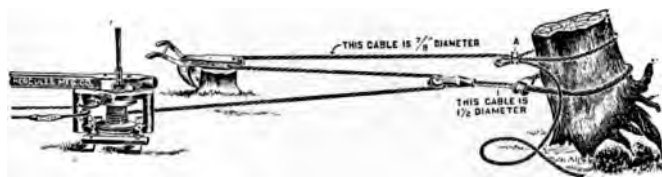

Fig. 30. Small Base Puller with Anchor Line, Also "Take-Up" Being Used on Stump

The sweep or lever to which the horses are attached can be extended beyond the axle, and this elongated end can have a weight fastened to it, to serve as a counter balance, and relieve the horses of the vertical load.

As the horses walk around the machine they have to step over the cable that is pulling the stump, and at times this interferes with the horses when there is a great strain on the cable. To overcome this, some stump-pullers have been made to be thrown out of gear and back into gear while there is a strain on the cable. This allows the horses to step over the cable without danger, and also admits of a stump being pulled where the horses cannot circle clear around the machine, but must stay on one side only. The machine can be thrown out of gear and the horses backed, to make a new pull.

Stumps are pulled either by a direct pull, (see Fig. 31), or by a double pull. Naturally the work is a little slower with the double pull than with the direct pull, *yet it sometimes pays to use it in preference to moving the machine so frequently, as would have to be done with a short rope and a direct pull.* It is seldom ad-

visible to use a short cable on a machine. One from 150 to 200 ft. is much better. Much more work can be done from one "set-up" of the machine with such a length of rope. For instance, in clearing large areas of land, a cable 50 ft. long will clear less than $\frac{1}{4}$ acre, a 100-ft. cable will clear nearly $\frac{3}{4}$ acre, while a 200-ft cable will clear nearly 3 acres, from one set-up.

There are several methods of taking up the extra length of cable. One is shown in Fig. 30, where it is made into a double pull. Some machines have a hand winder on the drum to take in the slack before starting the horses. This is a good attachment to any machine, as there is always some slack to be taken up, and it is done quicker by hand than by the team. Another method is to have a "take-up," shown in Fig. 32A. This allows the pulling cable to be hooked around any stump at any place on the cable.

The sizes of stump-pullers are governed by the pull they exert, which in turn is controlled by the size of the steel cable used on the machine. Cables from $\frac{1}{2}$ in. to $1\frac{1}{2}$ ins. are used; the smaller ones for machines to be operated by one horse, while on the larger ones four horses are sometimes used. Each manufacturer varies his machine as to sizes and numbers, and the weights likewise vary considerably, as catalog weights include equipment sent with puller, which alone, due to length of rope included, can make a variation in weight of over 100 lbs. Generally there are about eight different sizes and weights of machine made. The two smallest sizes will weigh from 200 to 400 lbs. The two medium sizes will weigh from 400 to 700 lbs. The light patterns of the large sizes will weigh from 700 to 1,000 lbs., while the heavy patterns of the large sizes weigh from 1,200 to 1,500 lbs., but some extra heavy machines weigh as much as a ton.

Various uses of a stump-puller are illustrated in Fig. 31. "A" represent a tree being pulled by direct pull; the chunk at the root of the tree forms a fulcrum over which to lift the roots running toward the machine. *This is often a great help, as the hardest pull sometimes comes when the tree is down.* "B" and "C" represe



Fig. 31. Large Base Puller and Various Uses to Which a Stump Puller Can Be Put

a tree standing so near the machine that, if pulled toward the machine, it would fall upon the horses. The stump at "B" stands beyond the tree, so that the tree is thrown away from the puller. In this manner a tree may be thrown in any direction. Likewise stumps standing inside the circle in which the horse travels may be pulled in this manner. "D" and "E" represent a large stump being pulled by a double pull, "E" being the anchor stump.

"F" and "G" represent a large tree being pulled by single power by hitching high, the rope going through a pulley or snatch block attached to the stump "G," thus allowing the horses to step over the rope. At "H" is shown a stump hook pulling out a low small stump, and "J" shows a coupler with four small chains attached for rapid work, pulling four small stumps or roots at a single pull.

There are numerous devices meant to be used with stump-pullers. The one shown at "J" in Fig. 31 is manufactured by the Milne Manufacturing Co., of Monmouth, Ill., to which we are indebted for the illustration.

The tool shown in Fig. 32B is a grub plow made by the Hercules Manufacturing Co., of Centerville, Ia., which firm makes the puller illustrated in Fig. 31. This grub plow is not only useful in pulling small stumps, but it can be used for grubbing up large and small roots, being propelled by the puller. This plow will save much money in grubbing for elevating grader work. There are other styles and makes of root hooks, mostly meant for roots that grow above the ground, as the palmetto does.

In operating a puller, the cable should not be wrapped on the drum more than once, as it cuts itself if several thickness of cable are coiled on the drum. "Take-ups" (Fig. 32A) should be used to prevent this.

Care must be exercised in placing the rope and hook around the stump. The rope should be fastened near the top of the stump, so as to get the greatest leverage, and the hook must be set as shown in Fig. 32. *If the hook is placed so it kinks the rope, the hook will be easily broken, or else it will cut strands in the cable.*

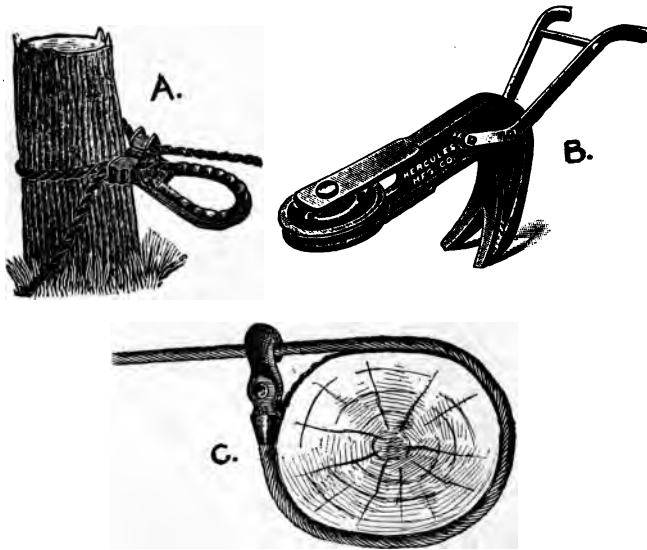

Fig. 32. Devices for Attaching Cables to Stumps. A, "Take-Up"; B, Grub-Plow; C, Stump Rope with Hook

When stumps are pulled, they should ordinarily be cut up for easy handling, as with long roots they are expensive to move. Many stumps can be handled if the roots are cut off with axes, while the largest stump can be broken up by dynamite by the method explained above. In cutting and breaking up stumps of hardwood trees, good "knees" that can be saved should usually be set aside to be sold, as they always bring a good price for ship building, and if convenient to ship them to market will help to pay for the grubbing. Contractors can often use them in building pile drivers and other machines.

In cutting timber where stumps are to be pulled, the stumps should be left high, as they are pulled much easier than when cut low. If the timber is valuable, a cord wood length (4 ft.) can be left above the roots and *after the stump is pulled this can be sawed off.*

Although the stump puller can pull trees, yet in most cases it is more economical to cut the trees and after-

wards pull the stumps, especially if the trees are very large. Very small trees will bend and break if an attempt is made to pull them up. Trees up to 16 ins. in diameter may be pulled.

A stump puller is likewise a useful machine in moving houses, especially if it can be thrown out of gear quickly. Contractors in clearing land for excavation frequently have frame buildings to move, and with a stump puller this work can be done cheaper than by almost any other method.

Methods for hitching to stumps. Several ingenious methods for hitching pulling lines to stumps and clusters of young trees have been devised by the W. Smith Grubber Co. of La Crescent, Minn., with whose permission we are using the accompanying cuts.



1

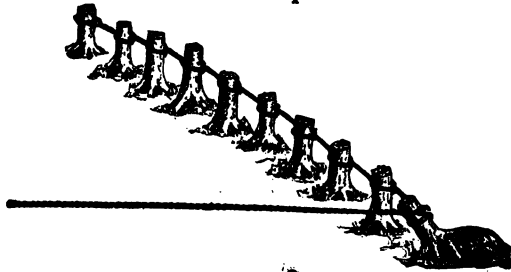

2

Fig. 33.

Fig. 33, 1 and 2, show the Rope Clutch used with the regular Pull Rope to make hitches to a half dozen or more small trees or stumps at once. The saving in time effected by this method of hitching can be seen at a glance.

Fig. 34 shows a method of hitching that is very popular in small second growth timber where the growth is close. These Cluster Ropes are 100% stronger than chains the same diameter, and weigh only one-fourth as mu

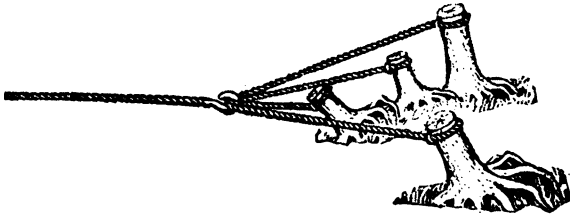

Fig. 34.

This method of hitching will give best results in clusters of small trees. No extras are required. The Pull

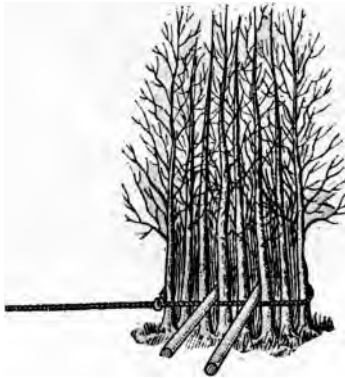

Fig. 35.

Rope is wrapped around a dozen or more, and a couple of poles placed in position as shown in the illustration

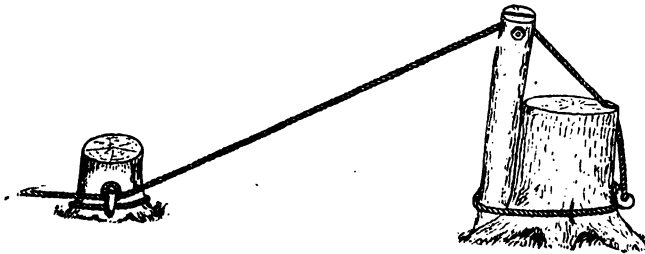

Fig. 36.

(Fig. 35). Instead of taking out one tree at once you take out a dozen.

Using an upright pole for greater purchase in pulling large stumps is one of the cheapest, one of the most convenient, and one of the most essential helps ever devised for clearing land, and probably one of the most neglected. It costs practically nothing to make and the time required for its use will be saved five times and over on each stump pulled. (See Fig. 36.)

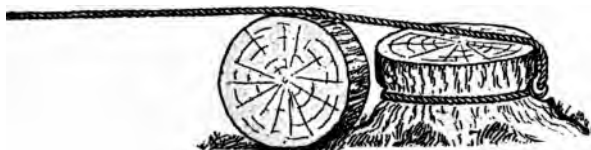

Fig. 37.

This illustration, Fig. 37, shows another convenient method of hitching to large stumps. You will note in both Figs. 36 and 37 the hitch is made to the opposite side of the stump from the machine, the back of the stump, the rope pulling over the stump. In Fig. 37 the block in front of the stump will be found a great aid in heavy work.



Fig. 38.

Fig. 38 indicates a proper and positive method of bracing the anchor stump. Instances have been met in this country where the soil is so loose that it is hard to find a suitable anchorage. This method is suggested as a remedy.

Fig. 39 shows the rope clutch employed in taking up the slack rope. It is one of the various uses to which this clutch may be put.

used for pulling piles and stumps. Its operation is simple yet very effective. One end of the sweep *S* rests on the ground, and the other end is mounted on a wagon wheel. The sweep is an 8 x 10 in. timber 24 ft. long, and at the free end, *B*, there is attached a single or double whiffletree. The arrangement at the fixed end, *A*, is somewhat more complex and may well be described in detail. About 3 ft. from the end is an eyebolt, *I*, to which is fastened an anchoring chain attached to a con-

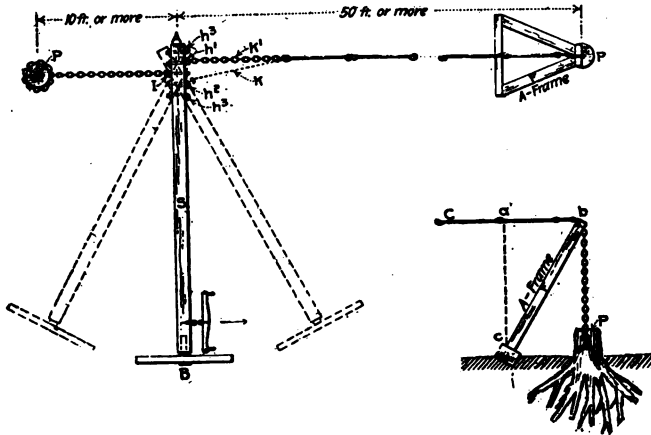

Fig. 42. Sweep Stump Puller

venient stump or "dead man," *P*. On each side of the eyebolt, and almost 4 in. from it are attached hookbolts, h_1 and h_2 , and still further away two similar bolts, h_3 and h_4 . The stump pulling wire cable is fastened to a short chain, *K*, and then carried over an A-frame *F* and attached to a stump as shown. The chain *K* is hooked to the bolt h_1 .

In operating it the lever, *S*, is drawn in the direction of the arrow, causing a strain on the pulling cable. The horse is driven ahead until the sweep has the position shown by the dotted lines, and when this position has been reached a short length of chain indicated by the dotted line *K* is hooked at one end to the pulling chain

and at the other end to the hook bolt h_2 . The horse is then turned and driven in the opposite direction, putting a further strain on the pulling chain and slacking the chain K so that it can be shortened and hooked up again when the horse has moved the sweep to the position shown by the left hand set of dotted lines. The horse is then started on its forward trip, then back again, and so on, pulling alternately on chains K and K_1 and putting, ultimately, an enormous strain on the stump.

An idea of the power exerted is gained from the following brief calculation. If the distance between the king bolt of the whiffletree and the bolt I is 20 ft., and if h_1 and h_2 are 4 in. (1-3 ft.) from I, the pull of the horse is multiplied $3 \times 20 = 60$ times. A horse capable of pulling 500 lb. would then put a strain of $500 \times 60 = 30,000$ lb. on the chain K and K_1 . Then in the triangle a b c, a b represents 30,000 lb. and a c represents the pull on the stump, which must always be greater than 30,000 lb. to an amount depending upon the inclination of the A frame; if the batter of the A frame is 1 in 3 the pull on the stump will be 40,000 lb. As a matter of fact, one horse cannot long maintain a 500 lb. pull, and a team must be used where such a pull is necessary.

Very large stumps can be pulled with this simple device and a team of horses.

From the figures given it is evident that heavy chains and cables must be used or else there will be frequent breaks.

One set-up of the machine can be used to pull a large number of stumps, since it is necessary to move only the comparatively light A frame. With a long cable, to give a good reach to the machine, there should be used take-ups like those shown with the style of stump puller shown in Fig. 30, else considerable time is consumed in taking up the slack of the cable. The crew to operate this style of machine consists of a foreman, three laborers and one span of horses, the daily cost being about \$16. This machine and the one shown in Fig. 43 were both used for pulling piles, the machines being adapted for either pile or stump pulling. Figs. 43 and 44 illustrate another sweep puller.

Methods and cost of removing stumps from a reservoir site in West Virginia. The following is by Victor F. Hammel in *Engineering and Contracting*, Oct. 25, 1911: The mountain reservoir of the Union Utilities Co., designed to supply Morgantown, W. Va., with an auxiliary gravity water supply system, is located in the foothills of the Allegheny Mountains, about 6 miles from that city. The site of the reservoir was heavily wooded and required some very difficult work of stump grubbing. It is on the method of removal of these stumps that this description is written.

The trees covering the reservoir site were principally oak, some pine and chestnut, with considerable undergrowth and saplings. The stumps were not exceptionally large, very few being more than 20 ins. in diameter, the run being between 6 and 20 ins., with an average of 14 ins. The marketable timber on the site had all been cut by a lumber mill previously, and the timber removed. As usual on such operations the height of the stump left standing averaged 2 ft., which was an advantage for working with a stump-puller.

The soil was loamy sand, clay and gravel with the sand predominating, being a sedimentary deposit washed into the valley. The clearing covered an area of 28.1 acres.

As it was the original idea to excavate the sub-soil (which had to be removed) with scrapers, the removal of the roots was an important matter as the progress of excavation is greatly retarded by the presence of roots in the ground even though these be small. A saving could have been accomplished had the grubbing been left to be done by the steam shovel which was later purchased and put in operation for the construction of the impounding dam and sub-soil excavation.

The grubbing was done by means of a stump-puller and a two-horse team, excepting in very difficult places, where it was done with hand labor, using mattocks and shovels, aided by blasting.

Blasting the stumps to loosen the soil around the roots and stringers was found a great aid, and dynamite was used whenever the stump was large and firmly rooted.

For placing the charge a small hole was dug in the ground under the base of the stump with a shovel, or a hole was made with a round stick or bar. An average of $\frac{1}{2}$ lb. of dynamite was used for each stump, and this amount was found sufficient in obtaining effective loosening for the subsequent removal with the puller. Fuse and caps were used in discharging the dynamite. The blasting usually preceded the puller a sufficient time and far enough in advance not to delay the work. Much of the shooting was also done at noon hour and after quitting time.

The style of stump-puller used on this work is shown by Figs. 43 and 44. Such a device can be built on the job by a contractor's force, a blacksmith being able to shape the metal parts and the whole put together by an ordinary carpenter. The chains and bolts should, of course, be purchased from a supply house as the cost of making them amounts to a great deal more than they could be bought for. The principle of this puller is very simple, being merely an adaptation of the principle of the lever. On account of the character of the soil and the root growth, the stumps could be drawn out of the ground by a direct hitch without an extra device for vertical pull, as required when the stumps have long tap roots.

The stump-puller consists of a long beam, at one end of which are fastened chains for attaching to the stumps to be removed, and to the stump which acts as the anchor, while the opposite end is mounted on an old wagon wheel with a king bolt for attaching a whiffle-tree. For the anchor stump a very large and firm one was selected and used to pull all the surrounding stumps without moving, this being accomplished with extra length of chain and extension rods. The anchor stump was later grubbed by hand. A team of horses was hitched to the boom and pulled by traversing in the path of an arc of a circle backward and forward, a distance of about 60 degrees or one-sixth of a circle. While the horses are turning at the end of a sweep the short chain on the opposite side of the bolt attaching the anchor link is hooked to the pulling chain and the horses pull in t

opposite direction, resulting in the continued forward pulling of the stump. There is no time lost in making this change, it being accomplished quickly, while the horses are turning. Occasionally when the stump was very firmly rooted some of the heavier roots were chopped loose with an ax and later dug out by hand.

Fig. 43 shows method of operating stump-puller. With the beam in the position RS, the pulling line consisting of rods and chain, is hooked to the hitching chain B, and the team of horses at C pull in the direction of

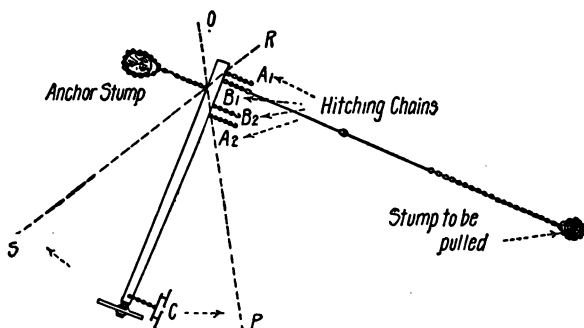

Fig. 43

the arrow. When at a point P in the position of OP, the chain B₂ is hooked to the pulling line AD, and the horses turned for a pull in the opposite direction. The process is continued until the stump pulls free of the ground. As can be seen there are two sets of hitching chains, A₁, A₂, B₁, and B₂, by the proper use of which the lever arm can be increased or decreased, resulting in a greater or less force being applied to the pulling of the stump. The method described was used effectively by the writer.

The force required to do this work consisted of one team and driver, two men for carrying the chain and grubbing, and one hitch man. The blasting was done *at odd times and with different men. No special foreman was over the grubbing gang, the supervision of the*

work being in charge of the general foreman, who also attended to the other work going on at the same time on the job. The hitching man spent all his time making the change of hitch when the team turned at the end of a sweep. The long and heavy chain required two men for handling and while they were unoccupied with this work they were kept busy hand grubbing, there being sufficient work of this nature to keep them constantly at work.

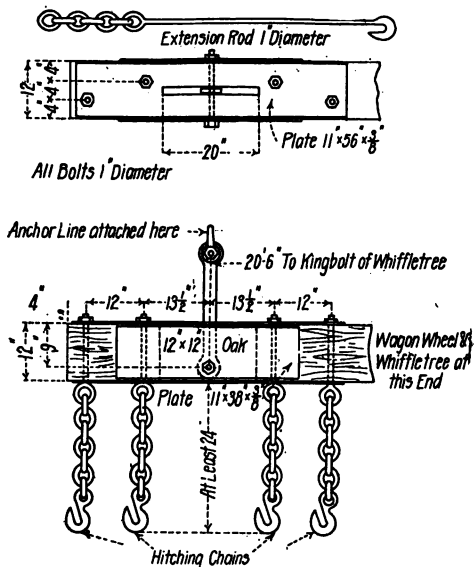

Fig. 44. Details of a Stump Puller

The chains used on this puller had seen considerable use on a steam shovel and needed constant repair. This item increased the unit cost of the work quite considerable as noted below.

The wages paid for team and driver were \$5, and for labor \$1.50 per day of 9 hours. The following is the average cost of pulling the stumps. The cost of the puller and the depreciation thereon are not included the data.

| | Cents |
|-----------------------------|-------|
| Labor | 14.0 |
| Repairs | 02.0 |
| Dynamite and blasting | 09.5 |
| Supervision | 02.0 |
| | 27.5 |
| Total per stump | 27.5 |

The stumps were dragged away to a storage pile to dry for subsequent burning. The cost thereof is not included in the above item. Some of the stumps were so large and heavy with the attached roots and soil that it required four horses to pull them.

The major portion of the work was done during the spring and early summer. Although the mud made work disagreeable at times, it was found easier for effective grubbing that the condition of the ground be moist and loose, so long as the mud was not so bad that the horses could travel the ground without becoming mired.

The grubbing was done by the company's own organization.

A tripod stump puller. The stump puller shown in Fig. 45 is of a type designed and built by the author for pulling piles and large stumps. With a 4-horsepower engine it exerted a pull of 50 tons.

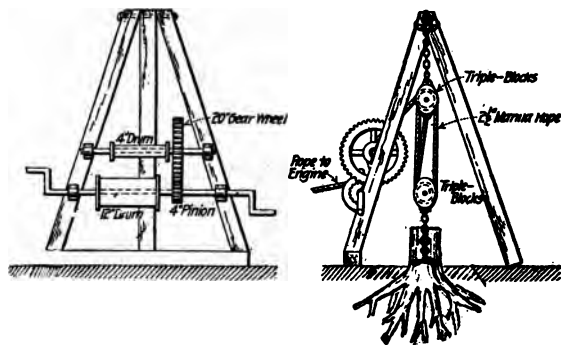
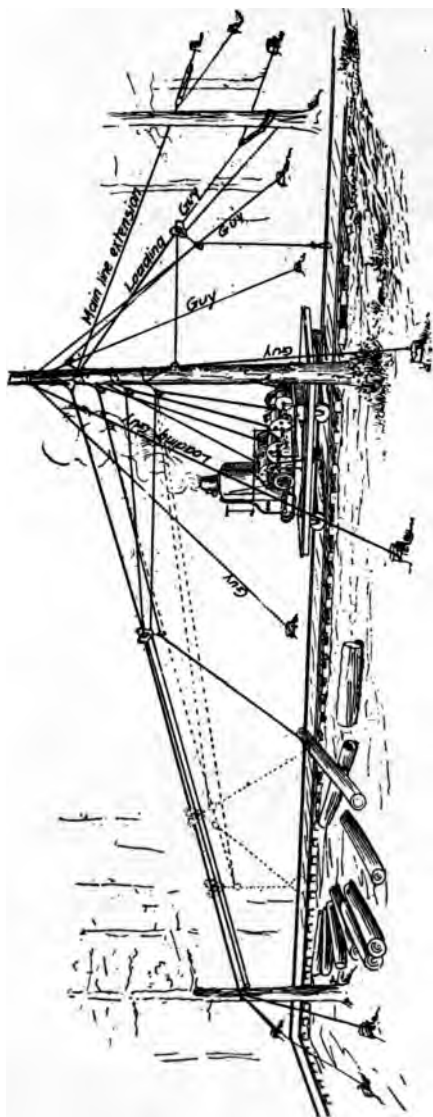

Fig. 45. Tripod Stump Puller

The legs of the tripod shown in Fig. 45 were 8 x 8 in. timbers, 10 ft. long. The rope is reeved through a set



Sketch Showing Rig for Log Skidding System, as Devised by the S. C. Flory Mfg. Co., Bangor, Pa.

Fig. 10.

of triple blocks and carried to the 4 in. drum. The gear wheel and pinion are respectively 20 in. and 4 in. in diameter. This arrangement gives a powerful strain on the chain or cable fastened to the stump. The stumps can be pulled by hand power or horses, or a line can be run from the 12 in. drum to a small (4 h.p. or larger) hoisting engine and the machine operated by it. This tripod outfit must be moved for each stump that is to be pulled.

With the gear wheels and tackle shown in Fig. 45 the power is multiplied 270 times. So powerful is one of these pullers that chains made of $1\frac{1}{4}$ -in. iron were broken, indicating a stress of about 100,000 lbs. developed with a 4-horse-power hoisting engine. Of course horses can be used instead of an engine, but if there is much pulling to be done an engine will prove cheaper. Large oak piles driven 27 ft. deep in hard gravel were pulled with this machine. With a crew of 15 men, consisting of 3 laborers, 1 foreman and 1 engineman, 15 piles averaging 12 ft. deep in the ground, were pulled per 10-hour day. With daily wages of the crew amounting to \$12, and $\frac{1}{4}$ ton of coal amounting to \$1, the entire cost was about \$1 per pile.

A tripod machine can be made for about \$100 and the pulley blocks and tackle will cost about \$100 more. Only very large and heavy pulley blocks should be used, for the strain is terrific. A $2\frac{1}{2}$ -in. manila rope is reeved through the triple-blocks and around the 4-in. drum. A $1\frac{1}{4}$ -in. rope is wound around the 12-in. drum and the leads to the engine or to the horses.

Rig for log skidding. A hoisting engine can always be used to good advantage in pulling stumps where there are many to pull. By means of a gear block and hooks it is easily rigged for the work. For this purpose the engine can be mounted on either a sled or on wheels and easily moved from place to place. These machines come mounted in this manner for logging purposes and are also mounted on railroad tracks and made self-propelling.

With such an outfit stumps can not only be pulled, but, with a small log skidding plant, both stumps and logs can be pulled up either to be burned or to be hauled

away later on. A log skidder consists, besides the hoisting engine, of a gin pole or main spar, erected and properly guyed, with several cables carried to smaller poles, upon which a small carriage travels. The logs and stumps are picked up and dragged or lifted onto a pile around the gin pole.

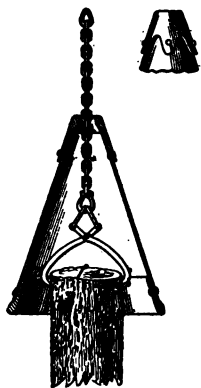

Fig. 47. McEwen Patented Cone

Fig. 47, showing a McEwen patented cone, manufactured by the Flory Mfg. Co. This cone is slipped over the chain or cable used in pulling the log and prevents the log from plowing into the ground or lodging against obstructions. It is a useful device. When the pile of stumps and logs is completed the blocks and cables are removed and the poles are burnt up with the pile of debris. The Lidgerwood Mfg. Co., of New York City, and the S. Flory Mfg. Co., of Bangor, Pa., make "log skidding systems" which are especially suited for clearing and grubbing by means of hoisting engines and cableway. See Fig. 46.

Use of a locomotive crane. A locomotive crane manufactured by the Browning Engineering Co., of Cleveland, has been used to assist in grubbing and clearing up the right of way of a railroad. After the track was laid the crane was used to pull up small stumps outside the road-bed but on the right of way, and all the logs, stumps and brush were loaded on flat cars and carried to a mar-

that was being filled in with earth and other materials.

No attempt was made to pull up a stump more than 10 to 12 ins. in diameter, as all the large ones had already been blasted, but the machine, rigged properly, could no doubt have pulled the largest stumps. The locomotive crane moved the car along as it was being loaded, and the crane was also used to help unload the cars. This was done by attaching a chain to one of the bottom logs or stumps on the side of the car farthest from dump and pulling this log or stump up and over, throwing off a great mass of the load at one lift.

The Clyde Iron Works, of Duluth, Minn., make the McGiffert log loader, which could be used for the same purpose. It has a long stationary boom. When loading the machine is elevated and stands on four steel beams, which allows empty cars to pass under it to take the place of the loaded ones. When not loading logs it is let down on its own trucks and is moved like a locomotive crane.

Use of a pile driver. Upon one occasion a pile driving machine was used to clean up the right of way of a railroad. A pile bridge half a mile long was being built through a river bottom, and nearly the whole area was heavily wooded. The trees were cut down and sawed into logs, but the stumps were not grubbed. As the pile driver moved along driving the piles, by the use of two snatch blocks and some lines, all the logs and brush were moved off the right of way and piled on the adjoining land. This work hardly retarded the pile driving, as the men needed to trim and mark the poles did the work while the crew on the machine was preparing to drive the new bent of piles. From 10 to 20 ft. of right of way was cleared at each move of the machine.

Clearing and grubbing methods. The land clearing demonstration trains operated during 1916 by the Agricultural Engineering Department of the Wisconsin College of Agriculture developed certain methods of clearing and grubbing. A description of these methods was given by Prof. C. D. Livingston in a paper presented at the recent road school of the University of Wisconsin. *Extracts from this paper by Engineering and Contracting, Feb. 21, 1917, follow:*

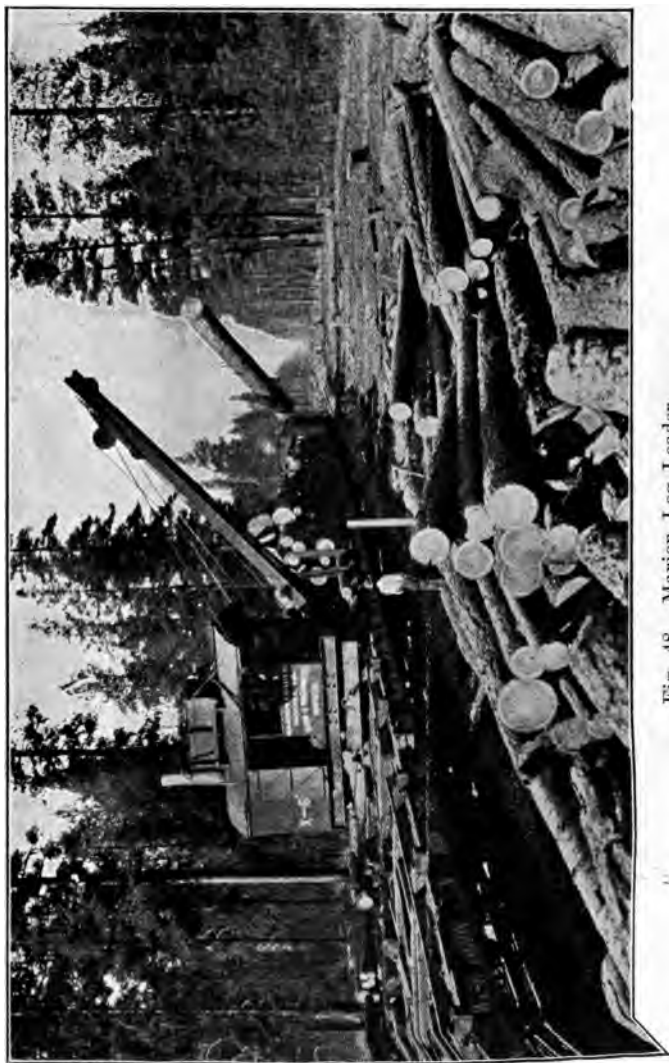

Fig. 48. Marion Log Loader

Burning is the usual method of disposing of the stumps. The pieces, therefore, should not be too large, they must be free from dirt, reasonably dry, and the piles should be high, narrow and compact. In order to bring this condition about, a combination method of using horse pullers, low grade dynamite, and horse pilers will probably serve the purpose better, in a majority of cases, than the method now in general use.

Pulling stumps. Horse power pullers are at present being looked upon with favor because the manufacturer has developed accessories which greatly add to the efficiency of their product. Dynamite is used to break up the big stumps, and serviceable pilers have been developed for use in connection with them.

Stump pullers are now made of cast steel instead of iron. This construction gives greater strength with less weight. It is very easy to haul the entire equipment from one place to another as the pullers may be equipped with demountable wheels. They are manufactured in different sizes to meet the requirements of various conditions of stumps, soil and finance.

More development has been made along the invention of accessories. The introduction of such new devices as "take-ups" and "power pulleys" has done much to increase the popularity of the puller. A "take-up" is an ingenious contrivance which enables the operator to connect a stump to any point on the main line. It is not heavy, is serviceable, and doubles the speed of clearing. While the first stump is being pulled, a second "take-up" is being fastened to a second stump. As soon as the first stump is out the first "take-up" is snapped from the main line and connected to the second. Little time is lost, for, as the second stump comes out, the operator unhooks the first "take-up" and places it about the third stump in readiness to be fastened to the main line as soon as it is free of its last hold.

"Power pulleys" allow the power at the machine to be multiplied and this enables the outfit to be constructed *of lighter materials*. By using these pulleys, a powerful *force can be exerted* at the stump to be pulled, and it has *been found that multiplying the power four times in a*

quadruple pull, will tip out all but the very largest stumps.



Fig. 49. Power Pulley Made by Zimmerman Steel Co., Bretten-
dorf, Iowa, and Snatch Block for Same Purpose Made by W.
Smith Grubber Co., La Crescent, Minn.

Cracking stumps by blasting. When the stump is out, split it up with low grade dynamite. The reasons for adopting this method are: It takes no longer to pull a whole stump at once by a power pull than to crack it first and make several straight pulls. All the roots are out and after dynamite has been used they are much more free from dirt than if the stump had been shot before pulling. The same amount of dynamite will leave the pieces more free from dirt and in better condition for burning when the stump is cracked afterwards.

The proper place to get the charge is right against the crown of the stump on the root side, just at the point where all the roots join. It is not necessary to bore in the stump but merely to get the charge at the pro-

place and then tamp it well with a stiff mud. Twenty per cent, low freezing ammonia dynamite, sometimes known as farm powder, is even better adapted for cracking than the higher grades. The action of the low grade dynamite is a shaking one, rather than the cutting action of the high explosives. It is also much cheaper.

Dynamite, of course, plays a very important part in all land clearing operations and there is manufactured a kind of dynamite for every use. Very often a lower grade dynamite which is cheaper would do the work even better than a higher priced article. The proper grade can be determined by trial or experience.

Generally speaking, the cheaper, low grade dynamite can be used on the heavier soils like the clays, silts and loams. This is especially true if the ground is wet or damp. As the soil becomes lighter or drier the percentage used must be increased until on the lightest and driest of sands 60 per cent straight nitroglycerine dynamite is needed. For general use in land clearing, 20 per cent, 30 per cent, and 40 per cent are best adapted.

Getting the charges of dynamite where they will do the best work is a very important part of stump blasting. If the load is placed too high, the dirt may be blown from between the roots or the stump only cracked. If the load was large enough to take the stump out, many of the roots surely must be cut off and left to interfere with the work of the grading gang. It is far better practice to use a slow dynamite and load deeper. Such a method will bring out all the roots and still break up the stump.

In blasting any stump the charge or charges must be placed where the roots are holding the tightest. With the cap and fuse method of firing, only one charge can be placed and that, under the center of resistance. But if electrical blasting is used a charge can be spread under a number of the larger roots and all loads exploded at the same time. This method of firing makes it possible to get the dynamite where it is most needed.

Some operators remove the wrappers from the cartridge so the dynamite can be packed in order to completely fill the hole. This is poor practice as the dynamite may become moist and therefore wasted. Dirt will

also mix with the free dynamite, which decreases its efficiency. A good way is to slit the wrapper three or four times the long way. When tamped the cartridge spreads to fill the bore hole. No dirt is mixed with it.

Piling and burning stumps. Getting the stumps on top of the ground is only half the story. They must be burned and that means getting them into a pile. Mechanical pilers of the boom type, however, accomplish this work about as satisfactorily as any method. A home-made one will do the work nearly as cheaply as will the higher priced ones. An automatic trip at the other end of the boom is a valuable asset as it allows piling and burning to be carried on at the same time. This means that stumps can be burned when more dirt is on the roots and when more water is in them than by piling first and burning afterwards. Green stumps, or those with dirt on the roots need to be continually jarred or they will not burn completely. Fresh stumps added to the pile at regular intervals serve this purpose. A piler makes a stump puller more efficient and larger pieces can be handled, which means a saving in dynamite.

Arrangement of multiple power hitches. The following Fig. 50 illustrates the use of single, double, triple and quadruple power hitches together with a "take-up" device manufactured by the Zimmerman Steel Co., of Bretendorf, Iowa, with whose permission the cuts are used.

Methods and costs of clearing logged-off land in the Pacific Northwest. The following is an abstract of circular No. 25, Bureau of Plant Industry, U. S. Dept. of Agriculture, by Harry Thompson, printed in *Engineering and Contracting*, Sept. 6, 1911:

The rapid decrease of merchantable timber and the consequent increasing acreage of logged-off land have brought to the attention of the people of the Pacific Northwest the importance of the agricultural development of this section of the United States. In order to make this land suitable for agricultural purposes it must be cleared for the plow. To do this the standing timber, the logs, the underbrush, and the stumps must be removed.

A preliminary investigation of the situation was made

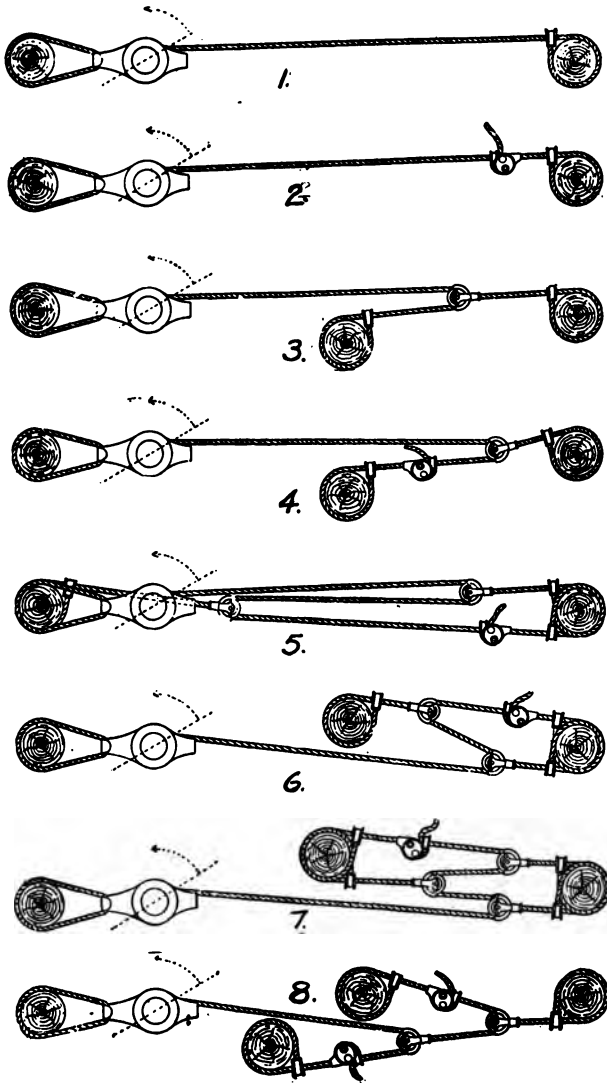

Fig. 50.

No. 1. A straight hitch without any extras. No. 2. A straight hitch with Cam Take-Up; pulls stumps near the machine. No. 3. Doubling the power with the steel double power pulley. No. 4. Doubling the power with the steel double-power pulley and Cam Take-Up where only one anchor stump is to be found. No. 5. Tripling the power with 2 steel double-power pulleys and Cam Take-Up using 2 anchor stumps to pull one large tough one. No. 6. Tripling the power with 2 steel double-power pulleys and Cam Take-Up. No. 7. Quadruple hitch with 1 double-power pulley and 1 quadruple-power pulley. No. 8. Quadruple hitch with 3 double-power pulleys.

during the summer of 1908 to determine the extent of the logged-off land, the methods in use at the present time, and as nearly as possible the cost of clearing by the different methods used. No experiments were undertaken, and consequently no definite figures can be given in regard to the cost of clearing by the different methods in use except as given by contractors and owners who had kept the cost of clearing separate from other expenses. The territory covered in this investigation embraces western Washington, western Oregon, and northern California.

The extent of logged-off land. In the State of Washington the 18 counties west of the Cascade Mountains have a total area of 8,700,000 acres of assessed land, as given by the various assessors of the respective counties. Of this, 429,000 acres are in cultivation or improved pasture, 5,034,000 acres in standing merchantable timber, and 2,352,000 in logged-off land. From this it will be seen that 27 per cent of the total acreage is logged-off land and that the acreage in cultivation, much of which is pasture land from which the large stumps have not been removed, is only 5 per cent of the whole area.

The timber lands in western Oregon and northern California are not nearly so accessible as those of western Washington. Neither is there nearly so much logged-off land, nor is this land so well adapted for agricultural purposes as that in Washington. While the demand for farm land in Oregon and California is well supplied by prairie and easily cleared brush land, the necessity for reclaiming the logged-off land in these states is not pressing. On the other hand, western Washington has but few valleys that were not heavily timbered at one time, and the demand for agricultural products far exceeds the local supply. Consequently, the demand for farm land and the idle wastes of cut-over land has brought the question of clearing this land squarely before the people. The character of the clearing ranges from the heavily timbered spruce and cedar lowlands through the benches and side hills covered with fir stumps and a dense growth of underbrush to the more sparsely covered hemlock ridges.

Character of the trees. The spruce stump is thought to be the most expensive to remove, owing to the fact that it is found only on the deepest soil, where it roots deeply, it often requiring a box (50 lbs.) of stumping powder to loosen a single stump 5 ft. in diameter.

The fir stump is the predominating stump of all logged-off lands in Washington and Oregon, and is removed by various methods described below.

The cedar grows to some extent wherever the fir is found and predominates on low ground.

All of the above trees have lateral root systems and do not root deeply except in loose or sandy soil, where the roots penetrate to a depth of several feet. On flooded or swampy land the roots are often partly above the surface.

In the logged-off lands of the redwood district of northern California there has been little effort made to clear the land for agricultural purposes, since prairie land is plentiful and the logged-off land is rough and hilly.

Some attempts have been made to clear the land of everything but the stumps and then to seed to orchard grass for cattle range. This work of clearing has been done for \$10 per acre. This method of making range has proved a failure in most cases, as the great quantity of brush and the sucker growth of the redwood stumps have almost entirely covered the ground in two or three years.

It is estimated that the logged-off land of California can be reclaimed at about the same expense as the fir-stump land of Oregon and Washington.

Most of the clearing that has been done in Oregon was done by cheap labor until recent years. The donkey-engine method has been used in some sections of the state recently.

Hand method of clearing logged-off land. Until recent years clearing was almost wholly done by what is now known as the "by-hand" method, where the farmer, equipped with peavey, mattock, shovel, and ax, undertook to put under cultivation the logger's stubble field. By this method the standing trees and brush

were slashed, generally during the summer months. Then, in September or October, after the first rainfall or when there was no danger to neighboring improvements or timber, a fire was started and allowed to burn over the entire slashing, when most of the brush and small logs were burned completely. The remaining logs were sawed into convenient lengths, piled, and burned. After the rains had softened the ground sufficiently the smaller stumps and roots were grubbed and pulled out. Often a stump puller of the capstan type was used in pulling the smaller stumps after they had been loosened by digging around them.

This type of stump puller is often used in clearing small tracts after the stumps have been broken into several pieces and loosened by the use of stumping powder, without which no clearing is undertaken in the present day. The stump puller should be of simple construction, strongly built. It generally consists of a capstan drum, a wire cable, and a sweep to which a team is hitched. Powder has been used in all clearing operations for several years, and all methods, except that of burning the stumps below the plow, are dependent upon it to loosen the stumps so that they may be taken out.

Donkey-engine method of clearing logged-off land. Some six or seven years ago when logs were down in the market and many logging outfits were idle, an enterprising logger took a contract for pulling the stumps from a meadow. He conceived the idea of using his donkey engine with its outfit of blocks and cables to pull and pile the stumps for burning. Since that time many such outfits have been engaged with varying success in clearing land. The usual method is to slash and burn over the tract to be cleared, in order to burn all the underbrush and as many small logs as possible.

Then all the stumps more than 1 ft. in diameter are split and loosened by a charge of stumping powder of from 5 to 20 sticks, according to size. A charge of twenty 1½ x 8-in. sticks will generally split a 5-ft stump into five pieces and loosen it so that an engine can pull the pieces from the ground.

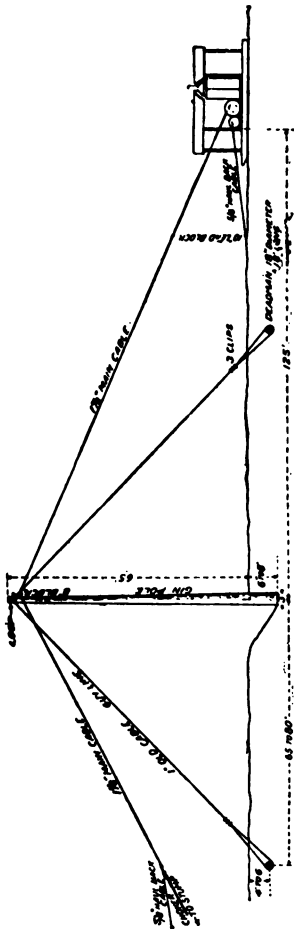

Fig. 51. Method of Setting Donkey Engine and Gin Pole in Clearing Land

A gin pole is then set in the center of a tract of 8 or 10 acres and held in place by four guy lines from the top. (See Fig. 51.) This pole should be 60 ft. or more above the ground. A block is fixed securely near the top of the gin pole, through which is passed the main cable from the engine. This cable has the usual hook, ring, and swivels at the end, and is usually 1 in. or $1\frac{1}{8}$ ins. in diameter.

The haul-back cable, which is usually $\frac{5}{8}$ in. in diameter, is taken to a "lead block" and passed around three sides of one-fourth of the tract to be cleared at this setting of the gin pole (see Fig. 52), and the end hooked into the ring of the main cable, thus forming an endless cable with the engine—one that will run in either direction to or from the gin pole.

In some cases, where the engine is built with the haul-back-cable drum above the main-cable drum, it is

better to fasten the block for the main cable about 5 ft. from the top of the pole and run the haul-back cable through a block on top of the pole. The haul-back drum is usually geared to run much faster than the main-cable drum.

Each outfit should have on hand at least four

“chokers” and a supply of lead lines and extra blocks. A “choker” is a section of cable from 20 to 30 ft. in length, with a loop in one end and a “choker hook” on the other.

The “choker” is passed around the stump and hooked upon itself. The loop is then caught in the hook of the main cable, and the load is ready to go to the pile.

While this load is going to the pile another is made ready, so that there is no time lost. When the cable returns with the empty “choker” it is loosened and another hooked into its place. As the loads come to the gin pole they are piled around it as closely as possible (Fig. 53) by a man on the pile.

This method, while an economic success in the hands

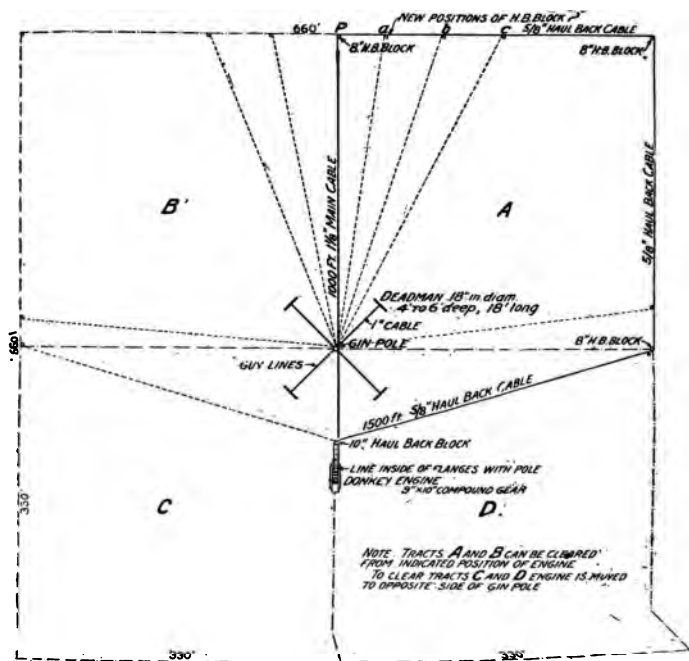

Fig. 52. Plan Showing Donkey Engine Rigged for Clearing L_o

of a few, has proved a costly method of clearing as handled by many others. If everything is handled to advantage by capable, experienced men this method has many points to its credit over any other method of clearing now in use, the greatest of which is the saving of time. It is also cheaper than the "by-hand" methods on large tracts of heavy clearing.

The question of using a large or small donkey engine has been discussed, but those who have been most successful in clearing are generally in favor of an engine with sufficient power to take all roots out with a straight pull, avoiding the use of blocks. A 9 x 10-in. compound gear, or 10 x 12-in. single gear, is said to be the best size for this work.



Fig. 53. Stumps Piled Around Gin Pole in Clearing with a Donkey Engine

Spar tree for logging topped with dynamite. The following extract from *Engineering Record* applies as well to clearing by donkey engine and gin pole as it does to logging:

In logging by the high-lead system, masts 150 to 200

ft. high are made by using a growing tree from which the small part of the top and the necessary branches are removed. Removing these tops with an ax and saw is likely to prove dangerous, and the Manley-Moore Lumber Company of British Columbia has devised a method of shooting the tops out with dynamite.

After the branches have been removed, a rigger climbs the tree, with a set of irons, to the point where it is necessary to cut off the top. Here the trunk is usually about 12 in. in diameter. The rigger ties a string of dynamite cartridges, fastened end to end like sausages, around the trunk at this point, inserts a blasting cap with about 20 ft. of fuse in one of these sticks, lights the end of the fuse, and is then able to descend to the ground and reach a place of safety before the explosion takes place. The tree top jumps into the air with the explosion, and the trunk is left ready for attaching the rigging for dragging in and loading the logs.

Suggested improvements in the donkey engine outfit. Further suggestions on the use of donkey engine outfits are made by Mr. Thompson in Bulletin No. 8 of the State College of Washington Experiment Station, as follows: The engine is the most important as well as the most expensive part of the outfit and most of the engines in use should be improved or replaced by a better one. An engine embodying the ideas of an experienced operator is outlined below. There has recently been put upon the market an engine designed especially for stump pulling. It is stronger in breaking out stumps at slow speed, but the speed for hauling to the pile is very little faster than that of the ordinary logging donkey. An engine for clearing purposes should have a larger boiler and be designed to run at a greater speed in hauling to the pile.

The greatest saving of time, after all losses on account of defective engines have been eliminated, can be effected by the use of the self-releasing "choker" (see Fig. 54). This "choker" releases the load upon the pile when the engine is reversed, in this manner: The large hook upon the main line is drawn back upon the loop upon the end of the "choker," while the trip line releases

“choker” and brings back the “choker.” This “choker” very rarely fails to release its load and the load can never be dropped, as it often is when using the old style choker. Its use makes the position of the pile-man unnecessary, thus eliminating that dangerous work. Fully twice as many loads can be put upon the pile by the use of this device as by the use of the old style “choker.” It is no heavier and is fully as easy to handle as the old one, being practically the same thing with the addition of the small trip line that requires to be hooked to the “choker hook” at each loading.

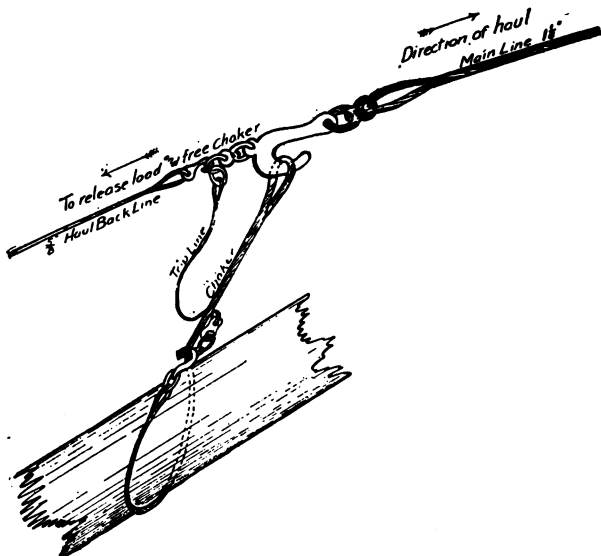

Fig. 54. Self-Releasing Choker

Another improvement can be made by using an electric bell outfit for signaling instead of the whistle wire or the other mode of signaling. This will be almost a *necessity* when using a high-speed engine and the self-releasing “choker.” This outfit should consist of a good bell, which could be fastened to the roof of the engine

shed, a strong battery that also may be placed in a box above the engine, the lead wires well insulated and made into a cable that can be laid upon the ground and brought around the pole to where the hook-tender and helpers are at work. The signals can be given by one of these men, thus dispensing with an extra man to do this work.

A small saving can be effected by placing spring "grease cups" upon the blocks on the gin pole. These cups should be large enough to hold a week's supply. It requires about 30 mins. each day to send a man up to oil these blocks when cups are not used.

Estimate and specifications for a donkey engine outfit. The following outfit is given by Mr. Sydney Ashdown, a man experienced in the donkey engine method of clearing land, having been with the Canadian Pacific Railway for some years in their land clearing operations, as the best outfit to be had for land clearing:

A compound geared yarder with two speeds to the main drum, giving approximately 100 and 250 ft. per min. with the haul-back geared to run at 300 to 350 ft. per min. The cylinders should be 9 by 10 ins. or 10 by 12 ins. The hauling drum should be fitted with a steam friction. The boiler should be extra large.

There should be 1,000 ft. of 1¼-inch main line of 6 strands of 19 wires each and 2,000 ft. of ⅝-inch haul-back line of 6 strands of 19 wires each.

| | |
|---|----------------|
| Donkey Engine | \$3,500 |
| Main line | 200 |
| Haul-back line | 150 |
| Bull block for gin pole | 75 |
| Six self-releasing chokers—¾-in., ⅞-in., 1-in. | 60 |
| Four haul-back blocks, hooks and swivels | 70 |
| Four guy lines (1-in.) 1,000 ft. | 150 |
| One lead block for haul-back line | 35 |
| Electric signal outfit | 10 |
| Tools, extra hooks, blocks, etc. | 150 |
| Total outfit | \$4,400 |

While this outfit is too expensive for small owners it could be purchased by a community or one or more such outfits could be operated by a county or a company.

clearing land. It would be found to be more satisfactory than the make-shift outfits usually found doing this work.

Gasoline engines for stump pulling. A few gasoline engines of small power have been tried in stump pulling upon small tracts of clearing. They are generally so arranged that the engine runs continuously, while the drums are started or stopped by means of a clutch or similar arrangement. In the gearing of these small engine outfits all speed is sacrificed to power. This makes them very slow, the load traveling to the pile much slower than a man can walk; as there is no change of speed no long hauls are made. Stumps must be very well split and loosened for an outfit of this kind and the piles are necessarily small. Two men can handle an outfit.

Two men with a good team, blocks and line can do fully as much as one of these outfits and at about the same cost.

TABLE XVI

COST OF CLEARING LAND BY VARIOUS METHODS IN WASHINGTON AND OREGON

| | | Cost per Acre |
|---|------------------------------|----------------|
| 2 acres, bench land | Powder & Stump puller | \$200 |
| 2 acres, low land (Many large cedar stumps) | Powder & Stump puller | \$200 |
| 35 acres bench land, by contract | Powder & Stump puller | \$125 |
| 10 acres, high land | Powder & Team | \$120 |
| 2 acres, high land | Powder & Burning | \$100 |
| 2 acres, high land (contract) | Powder & Grubbing | \$112 |
| 40 acres, high land (All grubbing and leveling included) | Donkey Engine | \$218 |
| 100 acres, high land (80 acres cleared for plow; 80 acres cleared for pasture; stumps not removed) | Donkey Engine | \$105 |
| 5 acres, high land (48 stumps per acre) | Donkey Engine | \$116 |
| 1,000 acres, high land (light clearing) | Donkey Engine & Stump puller | \$75 to \$125 |
| 50 acres, high and low land (In small tracts) | Donkey Engine | \$100 to \$150 |

HAND, HORSE, AND POWER STUMP-PULLERS 183

| | | Cost per Acre |
|--|-------------------|---------------|
| 5 acres, high land (Stumps only; other tracts from \$100 to \$150 per acre) | Donkey Engine | \$90 |
| 7 acres, low land (Heavy clearing) | Donkey Engine | \$120 |
| 12 acres, low land | Donkey Engine | \$84 |
| 23 acres, valley land (Meadow; 15 stumps per acre) | Donkey Engine | \$26 |
| 20 acres, valley land | Donkey Engine | \$105 |
| 12 acres, valley land (Cleared of stumps only) | Donkey Engine | \$36 |
| 24 acres, valley land (Cleared of stumps only) | Donkey Engine | \$40 |
| 12 acres, valley land (Spruce stumps) | Donkey Engine | \$100 |
| 20 acres, high land 28½ days' time; cleared of stumps only) | Donkey Engine | \$55 |
| 67 acres, high land (Light clearing) | Donkey Engine | \$68 |
| 10 acres, bench land (Heavy clearing) | Donkey Engine | \$123 |
| 20 acres, valley land | Donkey Engine | \$100 |
| 40 acres, bench land (Contract) | Donkey Engine | \$115 |
| 10 acres, bench land | Donkey Engine | \$100 |
| 4 acres, bench clay | Powder & Team | \$130 |
| 10 acres, bench clay | Powder & Grubbing | \$150 |
| 1¼ acres, low bench (Green timber, hemlock, fir, spruce) | Powder & Grubbing | \$357 |
| 700 acres, valley land (Brush; few stumps) | Donkey Engine | \$30 |
| 300 acres, bench land | Donkey Engine | \$100 |
| 11 acres, valley land (Pine, maple and cotton- wood) | Powder & Grubbing | \$43 |
| 4 acres, high land | Powder & Grubbing | \$100 |
| 5 acres, bench land (Second growth fir, 1 to 3 ft.) | Powder & Grubbing | \$100 |
| 1 acre, bench land (Large fir stumps) | Powder & Grubbing | \$138 |
| 5 acres, bench land | Grubbing | \$125 |
| 25 acres, valley land (Large stumps not taken out) | Grubbing & Team | \$20 |
| 35 acres, high land (Heavy clearing) | Donkey Engine | \$1 |

| | | Cost per Acre |
|--|-----------------------|---------------|
| 6 acres, bench land (Meadow, cedar and fir stumps only) | Powder & Stump puller | \$50 |
| 13½ acres, high land | Powder & Stump puller | \$90 |
| 46.7 acres, high land (40 stumps per acre) | Stump burning Machine | \$65 |
| 9 acres, valley land (Spruce stumps, some work done before) | Donkey Engine | \$125 |
| 1 acre, valley land (Spruce stumps only; other work done) | Donkey Engine | \$100 |
| 80 acres, bench land (Wood and lumber sold from this tract; 600 cords wood, 80,000 ft. b. m. lum- ber) | Donkey Engine | \$20 |
| 2 acres, bench land | Powder & Team | \$150 |
| 17 acres, bench land (U. S. Magazine site, 18 ins. below surface) | Powder & Team | \$105 |

Clyde Iron Works stump-pulling machine. This was described in *Engineering News*, Sept. 24, 1914: The machine described below will clear a tract of five acres (about 600 x 350 ft.) at one setting, and it pulls the stumps with a horizontal cable.

The machine, shown in Fig. 55, consists of a frame of 15-in. steel I-beams mounted on a pair of longitudinal 9-in. I-beams which form the runners. Each runner is curved upward to enable the machine to ride over obstructions, and is shod with a steel plate 20 in. wide. Steel plates are riveted to the bottom of the floor-beams of the frame, to protect the machinery from dirt and to give additional support on very soft ground. At the front end is a steel A-frame, 16 ft. high, to which are attached the guy lines of the 36-ft. boom. At the rear end is the hoisting engine and a vertical boiler, and over it may be a canopy roof for the protection of the operator. The frame is 32 x 9 ft., and the machine (with its cables and all equipment complete) weighs about 35 tons. Lighter machines of the same type are built.

A double-cylinder three-drum engine is used, with *cylinders 10 x 12 in.* for the larger machines. The front *drum carries the pulling cable*, and is geared for two



Fig. 55. Clyde Iron Works Land-Clearing Machine

speeds; for pulling the stump it exerts a pull of 145,000 lbs. with a speed of 30 ft. per min., while for skidding or hauling in the stump it has a speed of 350 ft. per min. The rear drum carries the outhaul cable for running out the pulling cable after it has brought in a stump, giving a speed of 800 ft. per min. The middle drum carries the piling line which is led over the boom and is used for stacking the stumps in piles ready for burning. The hoisting capacity is 10 tons.

When the machine is in position it is anchored by steel spuds driven into the ground through holes in the runners, or by chains attached to trees or stumps in the rear. The outhaul cable is then led around the area to be cleared, being passed through snatch blocks, as shown at 1, 2, 3 and 4, in Fig. 56, and led back to the machine, where its end is attached to the pulling cable.

The drum then hauls on the outhaul cable, thus running out the pulling cable to the first stump (Fig. 56). A choker line or short steel cable, having a hook at one end and a loop in the other, is then wrapped around the stump, and the loop is slipped over the hook on the pulling cable. The drum of this cable then hauls in on the slow gear until the stump is pulled from the ground, and then on the high gear until the stump is deposited at the machine. The choker line is released automatically and taken back by the outhaul cable.

When the machine has pulled all the stumps between it and point 4, the snatch block is shifted successively to points in the line 4-3, as shown. Then snatch block No. 4 is dispensed with, and the cable led directly to block No. 3. This in turn is shifted toward No. 2, and is then removed, and No. 2 is then shifted in the same way. As the positions of the snatch block are changed, the machine swings so that it is always in the line of the direct pull.

The entire area having been cleared, the pulling line is run out and anchored at the next position (shown at B, Fig. 56) and by hauling on this cable the machine pulls itself forward to that position. The outhaul cable *is then led around the new area and work proceeds as before.*

One piece of clearing done in Texas was on heavy clay land with pine stumps 10 to 40 ins. diameter averaging 44 per acre. The machine pulled, skidded and piled about 110 stumps per day, at a labor cost of about 28 cts. per stump, or \$12.32 per acre, clearing about 2½ acres per day. The working force was as follows, with a total daily cost of \$30, exclusive of fuel, interest, repairs and depreciation:

| | | | |
|-------------------|--------|------------------------|--------|
| 1 Foreman | \$5.00 | 2 Hookers (each) | \$2.00 |
| 1 Engineman | 3.50 | 1 Tongman | 2.00 |
| 1 Leverman | 2.00 | 1 Stump grubber | 1.50 |
| 1 Fireman | 2.00 | 1 Water team | 4.00 |
| 1 Helper | 2.00 | 1 Fuel team | 4.00 |

The machine is built by the Clyde Iron Works, of Duluth, Minn.

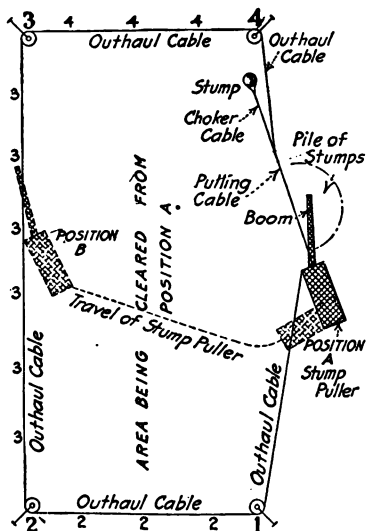

Fig. 56. Diagram Showing Field Arrangement of Clyde Land-Clearing Machine

A powerful steam land-clearing machine. The following account is taken from *Engineering and Contracting*, Aug. 12, 1914:

The engine shown in the illustration, Fig. 57, the Pioneer land-clearing machine, was designed to pull the largest stumps as well as the smallest, and with the further idea that such a machine ought to be able to travel readily from place to place, under its own power, to reach various jobs, or different parts of the same job. The difficulty in designing a light, portable machine of this kind was to obtain sufficient power and strength for the heavy work without exceeding the weight and size of the ordinary traction engine. This was accomplished by the use of a large steel tripod, which is swung from the side of the engine in such a way that while pulling the stump the tripod rests solidly on the ground, entirely free from rigid connection with the machine; while for moving from stump to stump the tripod is tilted and raised so that it hangs entirely from the engine and is clear and free of the ground.

The machine is steam power, of 20 horse-power capacity. It has a vertical boiler and a horizontal engine of a very rugged type, mounted on a substantial frame of structural steel. The engine is geared back through the medium of a suitable clutch, to the traction mechanism; while forward the power is applied to two drums mounted on the front end of the frame, geared down to give a very powerful pull. An auxiliary drum mounted on the gallows frame at the sides raises and lowers the tripod.

The wire rope which winds upon one of the drums leads to a pair of blocks suspended from the apex of the tripod, and by varying the number and arrangement of the sheaves practically any desired power could be obtained. However, it has been found that a pull about 45 tons, which is easily within the capacity of the machine using a pair of 5-sheave blocks, is ample for pulling stumps up to 4 ft. diameter. After the stump is pulled it is but the work of a few moments to lift the tripod, locate over the next stump, and drop the tripod into position again.

However, it is not necessary to use the tripod except *for that small percentage* of the stumps which are of *the largest size*. All the lighter growth, grubs and

smaller stumps are pulled by the ropes running forward direct off the drums. Working in this manner it is best to use plow steel wire ropes, $\frac{7}{8}$ in. diameter, and about 250 ft. long. The engine is located at a spot where it can be anchored to a stump in the rear, and where a big stump ahead will serve to attach two head blocks for the purpose of leading the ropes fairly onto the drums. Through these blocks the two ropes work simultaneously, covering a circle at one setting, amounting with the above length of rope to an area of over three acres.

The drums give a direct pull of about 7 tons, which suffices for all stumps up to 15 ins. diameter; and by doubling back through a single block, which involves but little loss of time, everything up to 20 ins. diameter is pulled. The comparatively light rope used enables it to be handled at maximum speed, a thing very essential where the grubbing is heavy.

The tripod also affords a means of piling the stumps. For this operation the rope is run through a block at the top of the tripod, and the tripod guyed to a stump in the rear. The stumps can then be skidded in, a higher speed on the drums being provided for this purpose, and they are readily dragged up into piles of considerable height.

This machine is sold by the Pioneer Land-Clearing Machine Co., 1220 First National Bank Bldg., Chicago. It is adapted to the use of parties developing tracts of land on a considerable scale; or for individuals located within the cut-over districts either north or south, it affords an opportunity for profitable contracting, as there is any amount of work to be had at profitable prices.

A rotary stump-cutting machine. (*Engineering and Contracting*, Jan. 20, 1915.) Fig. 58 shows a machine that removes stumps in an entirely different way from any previous device. It is known as the Moore rotary stump cutter. The novel features of this machine are its simple mechanism, its portability, and the rapidity with which it cuts out a stump.

The machine is mounted in an A-frame, and car

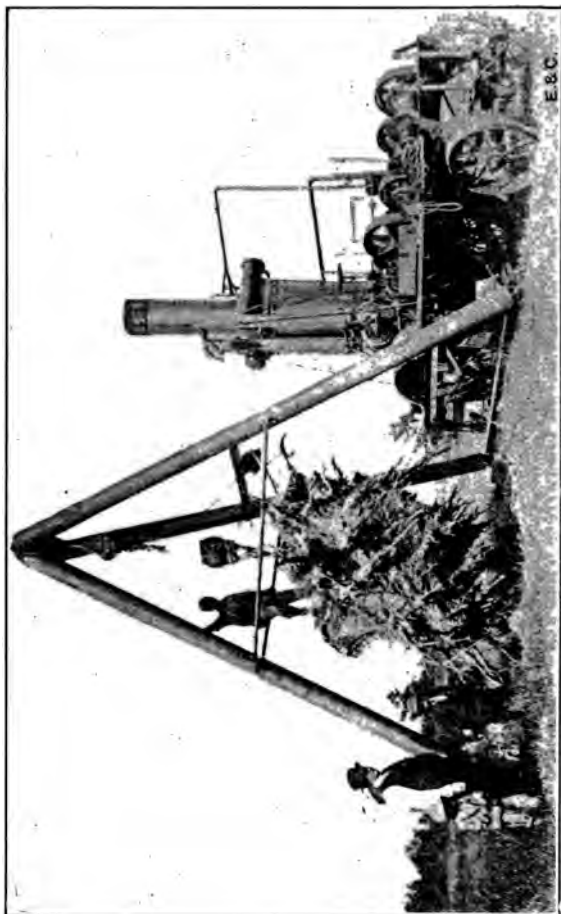

Fig. 57. Pioneer Land Clearing Machine

attached to the front of any standard oil engine tractor of 30 horse-power. The power to drive the cutter is transmitted by either a link or a rubber belt from the *main engine shaft* on the tractor; the pulleys are sized so that the cutter will develop 500 revolutions per minute, and the feed regulated to give it a boring speed of 3 ft.

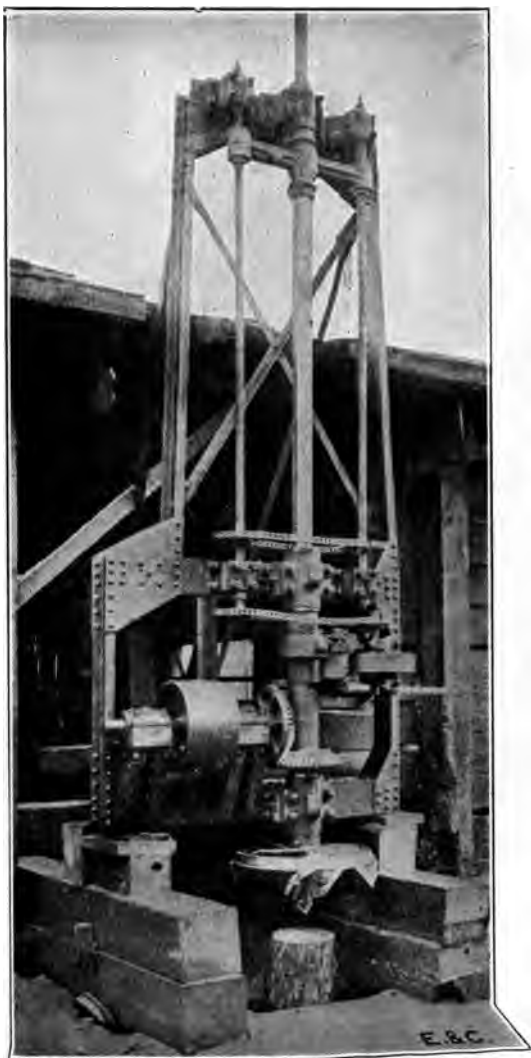

Fig. 58. Rotary Stump Cutting Machine

per minute, or $\frac{1}{16}$ in. per revolution. The cutter has a range of 6 ft., and is capable of boring 20 ins. beneath the surface of the earth. The chips are recovered from the cutter by a vacuum which deposits them to the rear to be either sacked or baled. Chips from the pine stump are valuable, as they contain resinous materials, from which the reduction plants manufacture various by-products. Quoting Mr. R. E. Doolittle's (acting chief of the Bureau of Chemistry) report on May 9, 1912, there are \$48.17 of different resinous by-products to the cord of pine stumpage.

This machine is best adapted to operate in the cut-over pine flats of this country where it will reclaim the land for agricultural purposes and at the same operation recover the valuable resinous material that is going to waste. The machine weighs 4,000 lbs., is economical to operate, and opens up a new field for contractors. The machine is controlled and manufactured by the Moore Rotary Stump Cutter Co., Inc., 213 Hennen Bldg., New Orleans, La.

Stump piling derrick and its use. The ultimate disposal of stumps is a serious problem often costing as much as the blasting and pulling. The following on this subject is taken from Bulletin 134 of the University of Minnesota Agricultural Experiment Station by A. J. McGuire:

In clearing land the piling and burning of stumps, small brush, trees and old logs are important. The chief objection to the use of a stump-puller alone on stumps over 12 ins. in diameter is that too much dirt clings to the roots. They are heavy to handle and hard to burn. The piling and burning must always be considered, as they have a great deal to do with the total expense.

The brush should be piled compactly in piles rather than in windrows. If the brush is very large and there are many small trees, the piles should be made tall and somewhat like a wigwam in shape. The brush and tree trunks should be in an upright position to secure good *draft in order that the burning may be more complete. Old logs and trees that cannot be made into cordwood should be skidded together with a team and burned as*

soon as possible after piling, as old logs will dry out slowly if rained upon. Fig. 59 shows a derrick for piling stumps, with self-tripping tongs. By means of the guy ropes the mast is set to lean slightly toward the pile, so when the stump is raised off the ground it swings, by its own weight, over the pile or fire.

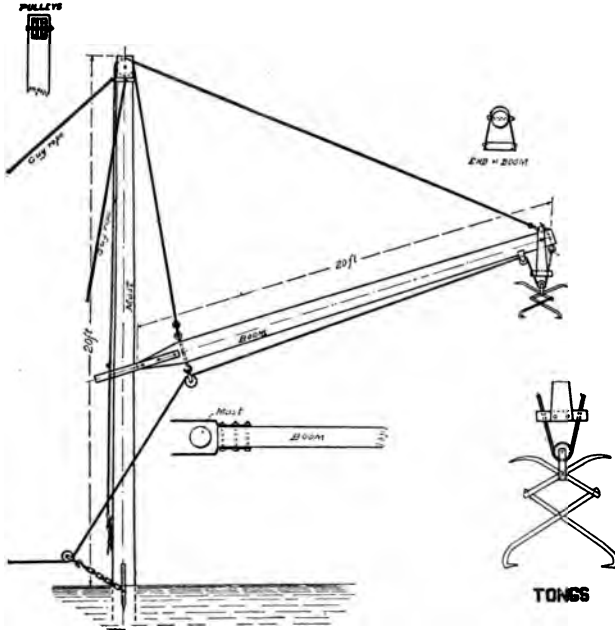

Fig. 59. Stump Piling Derrick

When very large stumps are blown out, or medium-sized ones pulled out, it requires a derrick to pile them satisfactorily for burning. Medium-sized stumps that have been blown out can be easily piled by hand. A good way is to make a rack for a low wagon for hauling the pieces and to begin the burning as soon as the piling is commenced. Start fires in several different places in the field, and, as each load is put on the wagon, haul;

to the nearest fire. If each load is piled on a different fire, the hauls will be shortened and each fire will be burned down sufficiently by the time the next load is brought to allow of its being driven up close to the fire and the pieces thrown directly on. If the piles are built up before burning, they should be tended after firing to prevent the fire from going out before the pile is completely burned. If the fire is properly tended and the outside pieces are constantly shoved into the center, the whole pile can usually be burned. It is easy to keep a fire going, but it is difficult to start it again if it dies before the pile is entirely consumed.

In sections where most of the timber has been cut, it will pay to pile and keep the stumps for fuel. Pine stumps furnish splendid fire-wood. It is best to look over the woodlot before burning the stumps.

If second-growth timber is to be removed and trees between 4 and 12 ins. in diameter are very numerous, it is cheapest to grub and pull if the land is needed for immediate use. This can be done best by cutting a few of the roots and pulling the tree out with a team or stump-puller. When a team is used, greater leverage can be secured by fastening the chain high up on the trunk. In this way a strong, quick team can pull out a good-sized tree when assistance is given by cutting the chief roots, especially if the trees are shallow-rooted as they generally are where the growth is thick.

Cost of clearing and grubbing the Scioto River reservoir in Ohio. Mr. Julian Griggs, in the *Journal of the American Society of Municipal Improvements* and in *Engineering and Contracting*, Oct. 17, 1906, gives the following description of the methods and costs of clearing and grubbing the reservoir formed by the Scioto River dam, near Columbus, Ohio:

All vegetable growth was cut down even with the ground, gathered into heaps, and burned, and the stumps and roots of all trees and shrubs 1 inch or more in diameter were grubbed to a depth of 1 ft. below the surface of the ground, gathered and burned. About 36 acres had been cultivated, but the remaining 255 acres were *hickly covered* with a growth of trees and shrubs, con-

sisting mainly of elm, oak, beech, hickory, maple, buck-eye, locust and sycamore, the latter growing as large as 5 ft. in diameter. The shrubs included osage, orange, willow and paw-paw, and the bottom lands supported a rank growth of weeds, horse cane 8 to 13 ft, high pre-dominating. Of the area cleared, 5.2 acres lay below the dam and was not grubbed.

The work was performed by contract at a price of \$70 per acre. The men were divided into three gangs: (1) A trimming gang, consisting of from 4 to 20 men under a foreman, equipped with axes and hoes, trimmed the limbs from the large trees as high as they could reach, cut off the small trees about 2 ft. from the ground, and grubbed out the brush and roots and gathered into piles everything that could be burned. (2) A pulling gang of from 6 to 12 laborers, equipped with a team of horses and a windlass or capstan stump-puller, pulled up the trees and stumps. (3) A cutting gang, consisting at times of the pulling gang and at others of a third gang, cut the trees and stumps into pieces that could be readily handled, grubbed out the exposed roots, and piled the whole for burning with the exception of such timber as could be saved for sawing.

Most of the stumps and many of the large trees were loosened or broken up with dynamite. The stumps were more difficult to grub than the trees.

A common harrow was the best tool for breaking down and grubbing the weeds.

About 3,000 saw-logs were sold at \$2.50 per 1,000 ft. B. M. More could have been sold had dynamite not shattered them.

The cost of the work was, \$159.50 per acre, as follows:

| | |
|---|----------|
| 255 days, superintendent, at \$4.17 | \$ 1,063 |
| 255 days, timekeepers, at \$1.75 | 446 |
| 1,030 days, foremen, at \$2.50 | 3,325 |
| 205 days, foremen, at \$2.00 | 410 |
| 54 days, carpenter, at \$2.00 | 108 |
| 435 days, dynamite men, at \$1.75 | 761 |
| 14,491 days, laborers, at \$1.50 | 21,737 |
| 222 days, single horse, at \$1.50 | 333 |
| 847 days, 2-horse team, at \$3.50 | 2,964 |
| 68,000 lbs. dynamite, at \$0.115 | 7,820 |

| | |
|--------------------------------------|-----------------|
| Machinery and repairs | 1,800 |
| Total, 255.6 acres at \$159.50 | <u>\$40,767</u> |

Due to delay in constructing the dam the entire site became covered with weeds during the following summer. These were cleared by day labor. Where possible a horse rake was used in gathering the weeds. This work cost \$1,969 or about \$7.86 per acre.

Cost of grubbing Douglas fir stumps. (*Engineering and Contracting*, June 15, 1910.) The following method was employed in clearing land of Douglas fir stumps on the Pacific Coast: A gin pole was erected in the middle of a 15- to 20-acre tract and a 60 horse-power logging engine was anchored near the outside of the plot. A 1 $\frac{1}{8}$ -in. cable was passed through the pulley at the top of the gin pole and hitched to the stumps in turn, each of which was hauled to the big pile which soon surrounded the base of the pole. When all the stumps had been drawn to the pile, the whole was fired and the small refuse cleaned up and burned. The cost of operating one machine for a week, during which time an average of 4 acres was cleared, was as follows:

| | |
|---------------------------------|--------------|
| Engineer, per week | \$ 23 |
| Fireman | 12 |
| Hook tender | 24 |
| Assistant tender | 21 |
| Signalman | 18 |
| Line assistant | 21 |
| Shovelman | 12 |
| Laborer | 12 |
| Water team | 16 |
| Wood, 15 cords, at \$3.80 | 57 |
| Powder | 200 |
| Dynamite | 15 |
| Fuse | 7 |
| Caps | 1 |
| Total for four acres | <u>\$439</u> |

Cost per acre, \$109.75, exclusive of interest, depreciation and repairs.

Added to the above is the cost of slashing the small growth which is put at \$50 an acre, and the final cleaning which can usually be done for \$10 an acre. This

makes a grand total of \$169.75 per acre for making the land ready for grading, or in the case of agriculture, ready for plowing.

About two days was usually taken in moving from one plot of land to another, including the setting up of the gin pole, anchoring and making ready for starting. There is a small cost which should be allowed for burning the piles amounting to nearly \$10 an acre. The cost of plant was as follows:

| | |
|--------------------------------------|---------|
| Sixty horsepower donkey engine | \$3,750 |
| 1,300 ft. 1¼-in. wire cable | 400 |
| 4,000 ft. ¾-in. haul-back rope | 300 |
| Other sundries | 100 |
| | <hr/> |
| Total | \$4,550 |

These data are compiled from the *Canadian Engineer* for Jan. 28, 1910.

Cost at Springfield, Mass. In a paper read by Charles R. Gow before the Boston Society of Civil Engineers and published in *Engineering and Contracting*, Jan. 18, 1911, the cost of clearing and grubbing for a water purification works at Springfield, Mass., is given as follows:

The work required to be done under this classification included the removal of stumps, roots, brush and rubbish from about 10.44 acres, comprising the area covered by the sedimentation basin and the earth dam. This site had originally contained a rather thick growth of timber, the average size of which may have been 12 ins. in diameter, but nearly all of this timber had been cleared prior to the letting of the contract, so that the removal of stumps and roots only was necessary.

The removal of stumps, consisting largely of red oaks, chestnuts and maple, was exceedingly difficult. The land was very rocky, with frequent outcroppings of ledge, and a large percentage of the stump roots either grew out of fissures in the ledge or extended underneath large boulders. A stump-pulling machine of the Hawk-Eye type was used, consisting of a vertical windlass operated by a lever and a horse traveling in a circle. A considerable number of stumps were removed by blast

ing, and many of them too large for the puller to handle were split with dynamite and pulled piecemeal.

A record of the number of stumps removed was kept and showed an average of 475 per acre. Owing to the fact that the basin was designed for use as a sedimentation basin, and that its bottom would consequently be covered by an increasing depth of silt and vegetable deposit, complete grubbing was not required. The bottom was entirely cleared of stumps, large roots and all loose material and was then burned over. The cost per acre for this grubbing (475 stumps per acre) is shown in the following table:

| | Per acre |
|--------------------------------------|----------|
| Labor pulling stumps | \$ 83.76 |
| Teams pulling stumps | 28.15 |
| Explosives | 9.06 |
| | <hr/> |
| Total cost for stump pulling | \$120.97 |
| Labor burning stumps | \$ 37.64 |
| Stump puller and special tools | 17.32 |
| | <hr/> |
| Total | \$ 54.96 |
| Cost per stump pulled, 37 cts. | |
| Labor grubbing roots | \$ 56.16 |
| Teams grubbing roots | 2.09 |
| Special tools and supplies | 1.97 |
| | <hr/> |
| Total cost of grubbing | \$ 60.22 |
| General expense, 12.9 per cent | 30.46 |
| | <hr/> |
| Total cost per acre | \$266.61 |

The cost as shown above is undoubtedly high for this class of work and may be accounted for partly by the fact that no special study was made of the possibilities of economic handling. This work was in general used as a spare job whenever there were extra men available. On the other hand, there is little question that the cost of grubbing work is too often underestimated and underbid and that the actual costs are in many cases much higher than popular impression would indicate. The general character of this work was probably more *difficult than the average case*, the rocky soil and the nature *of the growth rendering it very difficult*. Had it been

necessary, however, to completely remove all fine roots, the above figures would have been largely increased.

| | Per acre |
|---|----------|
| The contract price for grubbing was | \$150 |
| The maximum price bid was | 300 |
| The minimum price bid was | 100 |
| The average price bid was | 194 |

Costs of clearing land using a home-made horse stump piler. The following, by B. F. Faast, is from *Engineering and Contracting*, Nov. 22, 1911: Fig. 60 shows one of the cheapest ways yet devised for piling stumps and fallen timber. This piler is easily hauled

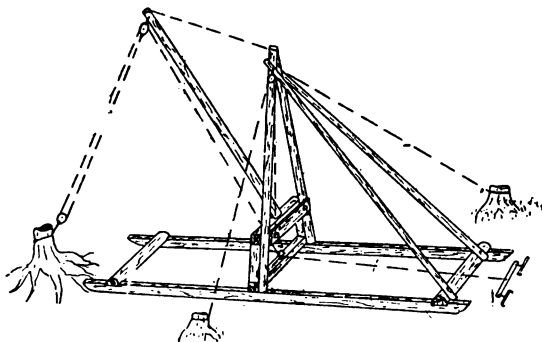

Fig. 60. Home Made Stump Piling Machine

to the stump field by a team of horses. The cable runs out 200 ft. or more. Additional power can be secured by adding more pulley blocks. The team is hitched on to one end of the cable and the stumps are hauled to the piler, are picked up by the swinging boom and dropped into piles at one operation. These piles are made about 20 ft. high. In this way large piles can be built so that when fired there will be heat enough to burn practically all the stumps. The following figures show the cost of clearing a 20-acre piece of hardwood land by this method:

Average pine stumps per acre, \$15; average hardwood

stumps per acre, \$30; average windfall logs per acre, \$10; average diameter of hardwood stumps, 14 ins.; average diameter of pine stumps, 30 ins.; average cost per acre, including pulling and piling stumps and windfall logs, \$16. Timber was cut four years before pulling the stumps.

A very high cost of clearing, logging and grubbing a railway right of way. The following cost data relate to work done by company forces on a railway right of way on the Pacific Coast, where the timber was exceedingly dense and large: The trees were mostly large firs, that averaged about 3 ft. in diameter, but no measurements were made of the diameter.

About 7 miles of right of way, averaging about 75 ft. wide, and totaling nearly 70 acres, were first logged off. The logs scaled 5,700,000 ft. B. M. or about 82,000 board feet per acre.

The cost of falling the trees and yarding the logs into piles along the right of way was as follows per 1,000 ft. B. M.:

| Labor: | Per M. |
|---|---------------|
| Swamping, at 25 cts. per hr. | \$0.12 |
| Falling, at 31 cts. per hr. | 0.37 |
| Bucking and Stripping, at 30 cts. per hr. | 0.43 |
| Building landings, at 31 cts. per hr. | 0.16 |
| Moving "donkey," at 31 cts. per hr. | 0.10 |
| Yarding logs, at 31 cts. per hr. | 1.00 |
| Water supply, at 30 cts. per hr. | 0.17 |
| Repairing "donkey," at 31 cts. per hr. | 0.04 |
| Miscellaneous hauling, at 34 cts. per hr. | 0.04 |
| Moving equipment to job at 31 cts. per hr. | 0.05 |
| Miscellaneous labor, at 27 cts. per hr. | 0.04 |
| Total construction labor | 2.52 |
| Other labor | 0.16 |
| Foremen, at 49 cts. per hr. | 0.18 |
| Time keepers, at 30 cts. per hr. | 0.09 |
| Blacksmith, at 31 cts. per hr. | 0.04 |
| Total Labor | \$3.00 |
| | |
| Plant: | |
| <i>Rent of donkey engines</i> | <i>\$0.17</i> |
| <i>Repairs of donkey engines</i> | <i>0.02</i> |
| <i>Wire ropes</i> | <i>0.06</i> |

| Plant: | Per M. |
|------------------------------|-------------|
| Temporary construction | \$0.11 |
| Miscellaneous | 0.06 |
| | <hr/> |
| Total Plant Expense | \$0.42 |
| | <hr/> <hr/> |
| Total Labor and Plant | \$3.42 |
| | <hr/> <hr/> |

Multiplying any of the above cost items by 5,700 gives the total cost of the item. The grand total for labor was \$17,100 for 55,000 hrs., or about 31 cts. per hour. The total cost of falling and yarding the logs was about \$280 per acre inclusive of the "plant expense."

About a third of the logs were loaded on railway logging trucks at the following cost per 1,000 ft. B. M.:

| Labor Loading: | Per M. |
|---|-------------|
| Loading crew, 33 cts. per hr. | \$0.66 |
| Other labor | 0.10 |
| Train crew, at 32 cts. per hr. | 0.09 |
| Water supply, and fuel, at 32 cts. per hr. | 0.03 |
| Repairing "donkey" and rigging | 0.05 |
| Repairing logging cars | 0.01 |
| Foreman, at 44 cts. per hr. | 0.17 |
| | <hr/> |
| Total Labor Loading | \$1.11 |
| | <hr/> <hr/> |

| Plant Loading: | |
|---|-------------|
| Temporary construction | \$0.16 |
| Interest and depreciation of "donkey" | 0.26 |
| Repairs on "donkey" | 0.13 |
| Cable, blocks, etc. | 0.08 |
| Rent of cars and locomotive | 0.30 |
| Water supply, etc. | 0.03 |
| | <hr/> |
| Total Plant | \$0.96 |
| | <hr/> <hr/> |
| Total Labor and Plant Loading | \$2.07 |
| | <hr/> <hr/> |

This makes a total of \$5.49 per M. ft. B. M. for falling, yarding and loading logs, exclusive of hauling. Hauling costs from \$0.50 to \$1.00 per M. where the haul to the saw-mill is short.

Grubbing logged-off land. After logging off the 7

acres as above recorded, the clearing of underbrush and dead timber and the removal of stumps was done in two sections, one of 45 acres and one of 25 acres. The first section cost \$211 an acre for labor alone (exclusive of explosives) and the second section cost \$317 an acre for labor alone. The detail labor cost of this clearing and grubbing on section No. 1 was as follows per acre (after the trees had been felled, cut up and yarded):

| Labor: | Per acre |
|--|-----------------|
| Slashing and burning brush ahead | \$ 45.00 |
| Pulling and piling stumps and logs | 48.86 |
| Clearing and burning behind donkey | 81.03 |
| Blasting stumps | 9.18 |
| Repairing "donkey" and rigging | 0.57 |
| Moving "donkey" from camp to camp | 0.75 |
| Blacksmith | 5.30 |
| Water supply | 2.45 |
| Miscellaneous hauling | 0.71 |
| Piling saws | 1.04 |
| Timekeeper | 5.05 |
| Foreman | 10.92 |
| Total labor | <u>\$210.86</u> |

The above given labor amounted to nearly 35,000 hrs. at 27 cts. per hour. To this labor cost of \$211 an acre for clearing and grubbing (after logging had been done) there must be added the cost of explosives and plant, which averaged \$82 an acre as shown in detail later on. This gives us a total of \$293 an acre for clearing and grubbing, section No. 1 after falling the trees and yarding logs, which, as above shown, cost \$280 an acre, making a grand total of \$573 an acre.

The labor cost of clearing section No. 2, of 25 acres, was \$317 per acre as follows:

| Labor: | Per acre |
|--|-------------|
| Slashing and burning brush ahead | \$ 38.13 |
| Pulling and piling stumps and logs | 70.71 |
| Clearing and burning behind | 158.61 |
| Blasting stumps | 9.51 |
| Repairing "donkey" | 0.15 |
| Blacksmithing | 3.58 |
| Water supply | <u>5.93</u> |

HAND, HORSE, AND POWER STUMP-PULLERS 203

| Labor: | Per acre |
|-----------------------------|-----------------|
| Miscellaneous hauling | \$0.37 |
| Timekeeper | 10.23 |
| Foreman | 19.83 |
| Total Labor | \$317.05 |

To this must be added about \$82 an acre for explosives and plant, making a total of \$399 an acre for clearing and grubbing after falling the trees and yarding the logs, which, as above shown, cost \$280 an acre. This makes a grand total of \$679 an acre!

Section No. 3, of 31 acres, had been logged off 20 years previously. It had a second growth of very heavy brush and small trees some of which were 6 ins. in diameter. The fir stumps, however, were sound and had to be blasted out. All second growth was close cut, and all old stumps were removed for the full width of right of way, and piled by a donkey engine. The old "down-logs" were also piled, and the whole was burned. The labor cost per acre was \$209, as follows:

| | Per acre |
|--|-----------------|
| Slashing and burning ahead, 23 cts. per hr. | \$ 43.44 |
| Bucking (or sawing up logs) 23 cts. per hr. | 2.64 |
| Blasting stumps, at 35 cts. per hr. | 7.45 |
| Blasting old logs, at 32 cts. per hr. | 0.97 |
| Pulling and piling stumps and logs with "donkey," at 30 cts. per hr. | 49.14 |
| Clearing and burning behind "donkey," at 25 cts. per hr. | 67.02 |
| Repairing "donkey" and rigging, at 30 cts. per hr. | 1.82 |
| Unloading and setting "donkey" (\$35) | 1.15 |
| Making sled for "donkey" (\$40), at 36 cts. per hr. | 1.30 |
| Rigging "donkey" (\$18) at 38 cts. per hr. | 0.58 |
| Blacksmith, at 30 cts. per hr. | 6.95 |
| Water supply, at 35 cts. per hr. | 8.70 |
| Hauling and miscellaneous | 1.62 |
| Timekeeper, at 26 cts. per hr. | 5.46 |
| Foreman, at 44 cts. per hr. | 11.01 |
| Total Labor, average 27.3 cts. per hr. | \$209.25 |

The explosives cost \$34 per acre, and the plant (rental, repairs, etc.) cost \$54 per acre, in addition to the above given labor cost of \$209, making a total of \$297 per acre, exclusive of the cost of falling and logging which had been done 20 years previously.

Section No. 4, of 24 acres, had been recently logged off. About one-quarter of this section had been covered with small timber (of a size suitable for "piles"), so that the removal of stumps, brush and old logs was much less expensive than for any of the three sections previously described. The labor cost on section No. 4 was \$159 per acre, or \$50 less than on section No. 3.

The four sections totaled 125 acres, and the average cost of clearing brush and "down-logs," removing stumps, and burning the entire mass, was as follows per acre:

| | |
|----------------------------|----------|
| Labor | \$221.46 |
| Plant and explosives | 81.70 |
| | <hr/> |
| Total per acre | \$303.16 |

This, it should be remembered, is exclusive of the cost of falling trees and logging off the merchantable timber.

The average cost of plant and explosives was as follows per acre:

| | Per acre |
|---|----------|
| Rent of "donkey engines." | \$14.09 |
| Oil | 0.58 |
| Repairs and supplies for "donkey" | 6.75 |
| Blacksmith shop supplies | 3.36 |
| Water supply materials (pipe, pump, etc.) | 8.15 |
| Freight and drayage | 2.02 |
| Wire rope | 9.55 |
| Tools (axes, saws, sheaves, etc.) | 7.44 |
| Miscellaneous | 1.77 |
| | <hr/> |
| Total Plant | \$53.71 |
| Explosives (powder, fuse and caps) | 27.99 |
| | <hr/> |
| Total Plant and Explosives | \$81.70 |

The price paid for "stumping powder" was 9.8 cts. per lb. Only a small amount of 49 per cent dynamite was used at 12 cts. per lb. Caps (XXX) cost 75 cts. per 100. Fuse cost 24 cts. per 100 ft. About 8 ins. of fuse and one-fifth of a cap were used per pound of powder. The work above described was all done by the *railway company's* own forces. It could probably have *been done by contract* at less cost per acre, but the com-

pany believed the saving thus effected would be more than offset by possible delays under a contract.

I have no records of higher costs for similar work, but the following conditions should be remembered in this connection:

First, the right of way was narrow (75 ft.). A narrow strip of land cannot be cleared as cheaply as a wide area. Second, the land had to be cleared and grubbed for the full width of the right of way, as it was nearly level land and low lying. Third, the undergrowth was rank, and the old fir stumps were numerous and very large. Fourth, wages were high.

Cost of pulling small trees with a traction engine. Mr. F. Hutchinson contributed the following to *Engineering and Contracting*, May 7, 1913: A field of about 60 acres had been neglected for many years and was covered with a scattering growth of small trees, varying from saplings 1 inch in diameter to young trees having a diameter of 7 or 8 ins. It was desired to clean up this land as cheaply and also as quickly as possible.

The owners of the land had a gasoline-kerosene traction engine of 45 horse-power, 4 cylinders, and with this it was determined to attempt to pull the saplings out bodily, without the aid of falls or snatch blocks. A $\frac{5}{8}$ -in. Norway iron chain 30 ft. long was also available. One end of this chain was attached to the draw bar of the engine by means of a clevis, and the other end was given one and one-half turns around the tree to be pulled, and the end of the chain made fast with a grab hook. The first trees attempted were about 3 ins. in diameter, of persimmon, elm and black jack, all well rooted. Taken one at a time, they pulled out without great difficulty. The experiment was next tried of pulling two trees with one hitch, by taking two turns of the chain about the first tree and leading the chain back to a second. This proved feasible, and the plan was extended, as experience was gained, to as many hitches as were permitted by the length of chain available, when the trees were not too large.

For the larger trees (4 to 8 ins.) a single pull to each tree was taken. We quickly learned to make the hi

as high above the ground as practicable, and a block of wood, 8 or 10 ins. in diameter by 4 ft. long, was thrown on the ground against the tree and directly under and at right angles to the chain. This bearing acted as a fulcrum when the tree was bent over by the pull, and served to bring a very powerful pull on the roots remote from the engine. In the case of a few 8-in. black locusts, a man stood by the tree with an ax and struck off the roots remote from the engine as the pull indicated their location. This process materially assisted. It was found that the most satisfactory results were secured with the larger trees when the hitch was made at a height of from 3 to 5 ft. above the ground.

The gasoline engine ran continuously, and the power was transmitted through an efficient friction clutch. The engine was reversible and could be reversed from forward to backward motion in 5 seconds. This feature was of value in providing slack in the chain immediately after a pull, and in backing down for the next hitch.

It was found necessary to use the full length of the 30-ft. chain in pulling the trees 4 ins. in diameter and over, as the tops often came down directly towards the engine with a vicious crash. The most efficient procedure was found to consist in running the engine at full speed, and to bring the tractor against the load slowly until the pulling chain became taut, then suddenly to bring the full power of the engine against the pull by means of the friction clutch.

Owing to the intermittent character of the loading it was found impossible to obtain satisfactory results with any fuel but gasoline. The fuel consumption was quite low for the reason that very little was used except at such times as the tractor was actually making a pull.

The following is a statement of the expense attending the cleaning up of this field, careful count being kept of every tree pulled. Everything smaller than about 3 ins. was cut down with an ax, but there were not a great number of these and they are not included in this *statement*.

| | |
|------------------------------------|---------|
| 108 gals. gasoline at 14 cts. | \$15.11 |
| Lubricants | 2.32 |

| | |
|---|---------|
| One engine man 4 days at \$3 | \$12.00 |
| Two laborers 4 days at \$1.75 | 14.00 |
| Charge for use of engine 4 days at \$5 | 20.00 |

| | |
|---|----------|
| Total for 1,246 small trees | \$63.43 |
| Average cost per tree for pulling | 5.1 cts. |

The trees were removed by teams, which chained them to a deep gully, into which they were rolled without further handling. The cost of removing trees was:

| | |
|-------------------------------|----------|
| Two teams 3 days at \$3 | \$18.00 |
| Average per tree | 1.4 cts. |

The total cost of pulling and removing was 65 cts. per tree, the trees being 3 to 8 ins. in diameter.

Cost and methods of clearing land in the Lake States.

The following is given by Harry Thompson and Earl D. Strait, in Bulletin No. 91 of the U. S. Department of Agriculture:

Two types of stump pullers are used—those that pull from the side, as the capstan (see Figs. 30 and 31), and the tripod type, which lifts the stump vertically (Fig. 61).



Fig. 61. Tripod Stump Puller

The capstan type of machine. The capstan type has the advantage that an acre or more of stumps can be pulled at a single setting. In pulling small stumps like scrub oak, jack pine, and certain kinds of hardwood, the saving in time is quite an item. In pulling small, sound stumps considerable time is saved in not having to dig root holes, which are necessary when using a tripod type of machine. With large stumps which are partly decayed this saving of time over that required in the use of the tripod type is about offset by the loss of time due to stumps breaking off. When this occurs, each large root must be dug and pulled out separately. The capstan machine will work on steeper land than the tripod, though no machine will do very satisfactory work on a steep hillside. By using the double and triple power arrangements of lines, the capstan machines will pull any white-pine stump in the Lake States. Many practical land-clearing operators using the capstan machines do not favor the use of the double or triple power in connection with these machines because of the time lost in adjusting the blocks and hauling the extra cable. They prefer to use a small quantity of dynamite under the larger stumps to split and loosen them. With the tripod type of machine the use of dynamite to loosen the stump is unnecessary, because these machines are powerful enough to pull any white-pine stump.

The tripod type of machine. Many stumping contractors clearing white-pine land in Michigan use the tripod type of machine. Any stump pulls more easily when lifted vertically than when pulled from the side. No anchor stump is required with this type. The vertical-lift machines are more powerful and seem to require less repairs than the average capstan machine. On the other hand, the machine must be moved for each stump, requiring four or five horses. Holes must be dug under the roots of each stump.

Power machines. Power machines have been used to a limited degree throughout this region. On large tracts of land, with a good outfit and an efficient crew, the clearing probably can be done with a power machine as

cheaply as and considerably faster than by any other method in use at the present time.

Cost of clearing land. The cost of clearing land in the Lake States varies greatly. It runs from \$5 to about \$100 per acre. The cut-over jack-pine land is the cheapest to clear and green hardwood and unburned swamp land the most expensive. The cost of clearing depends on the following factors:

(1) The quantity of second growth and logs per acre: The cost of disposing of these runs from \$5 to \$25 per acre, and even higher, with an average of about \$10.

(2) The kinds of stumps and the number of years since logging: All green hardwood stumps are very expensive to remove. Green birch and basswood are perhaps the most difficult. Most hardwoods decay so that they can easily be removed within 10 years from the time of logging, provided the sprout growth is not allowed to develop. Jack-pine and hemlock will decay at about the same rate as hardwood. Scrub oak is more resistant to decay than the other hardwoods. White pine and Norway pine will not decay in 50 years. The cost of removing pine stumps from 5 years to 25 years after logging is practically the same.

(3) The size and number of stumps per acre: The number of white-pine stumps per acre varies from 10 to 100, with an average of about 45. Some hardwood lands have more than 400 stumps per acre. Some contractors taking work by the job count the stumps and then add 10 per cent to the number to cover those that were overlooked or burned close to the ground. It usually is more expensive to remove severely burned white-pine stumps than it is to remove a sound stump. For this reason any system of burning that will not burn the roots below plow depth does not reduce the cost of stumping. A pretty close approximation of the average number of stumps per acre may be obtained by counting the number of stumps on several sample acres. A circle of 117.8 ft. radius contains an area of 1 acre. A rapid and convenient method is to stand on a stump and count *all the stumps* within 118 ft. of it.

(4) Soil and topography: Where stump-pulling machines are used, the cost of stumping in sandy soils is less than in heavier soils. Where dynamite is used, the cost in heavier soils is less than in sandy soils. On many tracts the land was swampy at the time of the tree growth, and the rooting system was consequently shallow. After the tract No. 20 was logged, fires burned off all the litter and most of the humus, leaving nearly all of the roots exposed. On many such areas a heavy team will tip out most of the stumps by a direct pull. For this reason this type of clearing is not usually expensive. (See "Tract No. 20.") It is more expensive to pull stumps on steep land than it is on level land. It is more expensive to stump stony land than land free from stones, because the cleaning of the stumps is more difficult.

(5) Size of area to be cleared and proximity to other clearings: Stump-pulling machines will usually reduce the cost of clearing, but it is not economical to buy one for the clearing of a small tract. In a locality where much clearing is being done it may be possible to cooperate in the purchase of stump pullers and explosives, and experienced help can be hired cheaper in such a region.

Table XVII gives an approximate idea of the cost of clearing white-pine land in this region. Additional data of the conditions of clearing on the 16 tracts summarized in this table, as well as details of the clearing of several additional tracts, are given in the pages which follow:

Tract No. 1 contained 40 acres of level land. The soil to root depth varied from medium to fine sand. The blasting was done in the spring of 1913 at a time when the ground was wet. The tract was logged 32 years before. Since that time it had been burned repeatedly, and there was no undergrowth. The tract averaged 4 or 5 small logs per acre. Of the stumps on the tract 16 per cent were so severely burned that it was necessary to partially dig the roots out and pull them with a team. The average number of stumps per acre was 50, of which 20 per cent were Norway pine and 80 per cent

TABLE XVII
 APPROXIMATE COST OF REMOVING STUMPS ON 16 TRACTS OF WHITE-
 PINE LAND, COMPILED FROM RECORDS KEPT DURING ACTUAL
 OPERATIONS

| Tract No. | Acres | Stumps | | Soil and subsoil | Method | Contract price | Cost, including labor | | Per acre |
|-----------|-------|---|--|------------------|-----------|----------------|--|---|----------|
| | | Aver- age di- ameter (inches). | Aver- age di- ameter number per acre | | | | Pulling (a) per stump Actual cost | Per stump, includ- ing dis- posal | |
| No. 1 | 40 | 20.2 | 50 | Sandy | Explosive | | | \$0.463 | \$23.13 |
| No. 2 | 3 | 18-36 | 99 | do | do | | | | 86.00 |
| No. 3 | 7 | | 48 | Clay | do | | | | 28.57 |
| No. 4 | 24.2 | 19.25 | 12 | Sandy | Capstan | | \$0.259 | | 5.99 |
| No. 5 | 50 | 22 | 20 | Sandy loam (b) | do | | 372 | | 13.98 |
| No. 6 | 1 | 18.6 | 78 | Sandy | do | | 144 | | 25.65 |
| No. 7 | 60 | 24.6 | 41 | Clay | do | | | | 24.07 |
| No. 8 | 30 | 24 | 82 | Sandy loam | Tripod | | \$0.32 | | 28.93 |
| No. 9 | 30 | 28 | 67 | do | do | | 19 | | 23.67 |
| No. 10 | 46 | 28.6 | 39 | Silt and clay | do | | 35 | | 27.91 |
| No. 11 | | | | do | do | | | | |
| No. 12 | 40 | | 60 | Sandy | do | | 465 | | 806 |
| No. 13 | 20 | 23.2 | 65 | do | do | | 18 | | 14 |
| No. 14 | 7.4 | 26.77 | 28 | Sandy loam | do | | 387 | | 320 |
| No. 15 | 40 | | 90 | Sandy | do | | 50 | | 387 |
| No. 16 | 35 | | 35 | do (b) | do | | 25 | | 563 |
| No. 17 | | | | do | do | | 333 | | 25 |
| No. 18 | | | | do | do | | | | 250 |
| No. 19 | | | | do | do | | | | 250 |
| No. 20 | | | | do | do | | | | 20.00 |

(a) The operation of "pulling" includes getting the stump out of the ground, cleaning the dirt from its roots, and leaving it where it will not settle back into the ground.
 (b) Clay subsoil.
 (c) Tracts Nos. 7 to 13 and 15 were stumped by experienced contractors, who were well equipped and employed experienced men with heavy teams accustomed to the work. The average landowner can not safely figure on getting his stumps pulled for less than these contract prices.

were white pine. The diameter of the stumps at the cut-off varied from 6 to 30 ins., the average being 20.2 ins.

The owners of this tract had recently purchased a capstan stump puller. With an inexperienced crew the cost of pulling and disposing of the stumps, as shown in Table XVIII, was practically the same as with dynamite.

TABLE XVIII

COST OF LABOR AND MATERIAL IN CLEARING AN ACRE OF TRACT

| Item | No. 1 | Total |
|--|-------|----------|
| Blasting stumps: | | |
| 1 powder man, 1 day | | \$ 2.00 |
| Dynamite, 75 pounds at 13 cts. | | 9.75 |
| Caps and fuse | | 1.13 |
| Pulling roots and piling and burning stumps: | | |
| 3 men, 1 day each at \$1.75 | | 5.25 |
| 1 man with team at \$5.00 | | 5.00 |
| | | \$23.13 |
| Total cost per acre | | \$ 0.463 |

Tract No. 2. Three acres of pasture land having a sandy soil, containing 297 white-pine stumps 18 to 36 ins. in diameter, were blasted by the use of 1,200 lbs. of powder containing no nitroglycerin. This is an average of 43 cts. per stump, including the cost of labor for doing the powder work. The cost of piling and burning is equal to the cost of blasting, which makes an average of 86 cts. per stump and approximates \$86 per acre.

Tract No. 3. Seven acres containing 334 white-pine stumps upon pasture land having a clay soil were blasted, piled, and burned at a cost of \$200, an average of 60 cts. per stump and \$28.57 per acre.

Tract No. 4 contained 24.21 acres of level land having a sandy-loam soil within root depth and practically no stones. The outfit used was a capstan stump puller, with 200 ft. of 1-inch cable on a drum and an additional length of 150 ft. of 1-inch cable, giving the machine a pulling radius of nearly 350 ft. The other tools used were 15 ft. of 1¼-inch double-power cable, 14 ft.

of 1 1/8-inch cable, shovels, axes, a bar, and a mattock.

The pine of the tract had been logged about 30 years ago. The hardwood had been cut off 7 or 8 years ago, except where noted. The hardwood stumps were so rotten that they were very easy to remove. The tract had been burned repeatedly since logging. Scarcely any vegetation or sod was left to retard the work of cleaning the soil from the stumps. There was a very scattering growth of poplar and bird cherry, averaging about 3 ft. in height on the tract. Included in the 290 stumps were 76 "snags" or stumps that had been burned close to the ground, leaving the roots in the ground. These snags are fully as hard to remove as the average stump. The stumps were piled later in the year by means of a gin pole. About 70 per cent of the stumps were white pine. The stumps averaged 19.9 ins. in diameter.

TABLE XIX

| | Total |
|---|----------|
| Crew: | |
| 2 machine men, 6 days each at \$1.75 | \$ 21.00 |
| 2 men to clean stumps, 6 days each at \$1.75 .. | 21.00 |
| 1 team and teamster, 6 days at \$4.00 | 24.00 |
| Use of machine, 6 days at \$1.50 | 9.00 |
| Piling and burning (estimated) | 70.00 |
| | <hr/> |
| Total | \$145.00 |
| Average per acre (12 stumps) | 5.99 |
| Average per stump | 0.50 |

The average height of the pine stumps was 33 ins. The average number pulled each day was 48. The cost of pulling, cleaning, and tipping was 25.9 cts. per stump. Dynamite had been used in stumping this land, but because of the loose nature of the soil it had proved too expensive.

Tract No. 5 contained 50 acres of very gently rolling pasture land with sandy-loam soil and clay sub-soil. The outfit consisted of a capstan stump puller, shovels, axes, and bars. The stumps were piled with a light derrick. Details of the cost of removing 1,018 stumps from this field are as follows:

TABLE XX

| | Total |
|---|----------|
| Pulling stumps: | |
| 1 man, 45 days at \$1.75 | \$ 78.75 |
| 1 man, 3 days at \$1.75 | 5.25 |
| 1 man with team, 45 days at \$4.50 | 202.50 |
| Use of stump puller, 45 days at \$1.50 | 67.50 |
| Dynamite, 200 pounds, at 12 $\frac{3}{4}$ cents | 25.50 |
| Caps and fuse | 1.41 |
| Piling and burning stumps: | |
| 3 men with teams, 20 days each at \$4.50 | 270.00 |
| 1 man, 120 days at \$1.75 | 35.00 |
| Use of stump piler, 20 days at \$0.75 | 15.00 |
| <hr/> | |
| Total | \$698.91 |
| Average per acre | 13.98 |
| Average per stump | 0.686 |
| Average per stump for pulling | 0.372 |
| Average per stump for piling | 0.314 |

The pulling was done in 45 days, an average of 23 per day. The average number of stumps per acre was about 20. This tract was logged 30 years ago. Fires had kept down all underbrush. All logs had been removed. The rooting system of the stumps was shallow. In burning, the stumps were placed about 50 in a pile. They were set on fire at night, and usually the following morning the unburned stumps were repiled. The sizes of 87 white-pine stumps measured on this tract were as follows: 16-inch, 7; 18-inch, 12; 20-inch, 18; 22-inch, 17; 24-inch, 16; 26-inch, 10; 28-inch, 4; 30-inch, 2; 32-inch, 1. The average diameter was 22 ins. and the average height 33 ins.

On a neighboring tract, similar in all respects, the stumps were pulled and cleaned under contract for 40 cts. each. Here three men with a light team, using a capstan machine, pulled an average of 20 stumps a day. The man for whom the stumps were pulled under contract formerly used dynamite of 40 per cent strength and pulled the remaining roots with a team, using a block and line. He also tried heavy blocks and line. All these methods were found less satisfactory than a contract at 40 cts. per stump. In piling stumps a *der-rick* was used, and with the same crew an average of 50 stumps a day was piled.



Fig. 62. Light Derrick Used on Tract 5

Tract No. 6 contained 1 acre of level land, having a loose, sandy soil. It was cleared in August, 1913. The outfit used was a capstan stump puller. At the time of tree growth this tract was wet; as a result the stumps were shallow rooted. The tract was logged about 35 years ago. Repeated fires since that time had burned off the litter until the roots of the stumps were well exposed, and there was practically no undergrowth or logs on the tract. The sizes of 62 white-pine stumps, selected at random and measured on this tract, were as follows: 12-inch, 4; 14-inch, 8; 16-inch, 9; 18-inch, 12

20-inch, 11; 22-inch, 9; 24-inch, 9. The average diameter was 18.6 ins. and the average number per acre was 78.

The low cost per stump of clearing this tract was due to the small size of the stumps and to the fact that the rooting system was very shallow. On this farm the actual cost of clearing over 100 acres of land has been \$39.30 per acre. About 50 per cent of this land is as described above. The remainder is low, wet, sandy land with cedar, tamarack, and occasional white-pine or Norway-pine stumps. The average number of stumps per acre was about 12, and their average diameter was about 10 ins.

TABLE XXI

COST OF CLEARING TRACT No. 6

| | |
|-----------------------------------|---------|
| Pulling stumps: | |
| 3 men at \$1.75 | \$ 5.25 |
| 1 team 1 day | 4.50 |
| Use of stump puller | 1.50 |
| Piling and burning stumps: | |
| 2 men 1.2 days at \$1.75 | 4.20 |
| 1 team 1.2 days at \$4.50 | 5.40 |
| Repiling stumps (time estimated): | |
| 2 men, 0.6 day at \$1.75 | 2.10 |
| 1 team, 0.6 day at \$4.50 | 2.70 |
| <hr/> | |
| Total for 1 acre | \$25.65 |
| Total per stump | 0.329 |

Because of the shallow rooting system and small size of the stumps, most of them could be pulled by a 2,800-pound team without the use of blocks and line. The stumps that could not be pulled by a team were split by a small charge of dynamite, and the remaining pieces were pulled out by a team. The second growth on this land consisted of poplar and bird cherry. Small logs were numerous. The various items entering into the cost of clearing were not kept separately. The superintendent said that they were approximately as follows:

| | |
|--|---------|
| To cut, pile, and burn brush, per acre | \$10.00 |
| To pile and burn logs, per acre | 12.00 |
| To pull, pile, and burn stumps, per acre | 17.30 |
| <hr/> | |
| Total cost per acre | 39.30 |

Tract No. 7 contained 60 acres, principally of heavy clay soil, in a few places having sandy-loam soil with a heavy clay subsoil 6 ins. below the surface. The land was nearly free from stones and was gently rolling. The outfit used was a tripod stump puller. This tract had been logged 20 years before. All the stumps were white pine. There was no undergrowth or logs. The tract had been pastured several years and at the time of stumping was covered with a fairly good clover sod.

The sizes of 354 white-pine stumps selected at random and measured on this tract were as follows: 12-inch, 2; 14-inch, 2; 16-inch, 11; 18-inch, 28; 20-inch, 37; 22-inch, 35; 24-inch, 88; 26-inch, 65; 28-inch, 42; 30-inch, 21; 32-inch, 13; 34-inch, 6; 36-inch, 4. The average diameter was 24.6 ins. The average height was 36 ins. The total number of stumps pulled was 2,464, the average per day being 54. The average number per acre was about 41. The stumps on this tract were piled in the fall of the year and will be permitted to dry out for about two years before any attempt will be made to burn them. The cost was:

TABLE XXII

| | Total |
|---|-----------|
| Pulling, cleaning, and tipping stumps: | |
| 2 men, 46 days each at \$1.75 | \$ 161.00 |
| 2 men with team, 46 days each at \$4.50 | 414.00 |
| Use of machine, 46 days at \$1.50 | 69.00 |
| Piling and burning (estimated) | 800.00 |
| | <hr/> |
| Total | \$1444.00 |
| Average per acre | 24.07 |
| Average per stump | 0.586 |

The work of stumping this tract was difficult because of the nature of the soil and size of the stumps. It was done under contract by one of the largest stumping contractors in Michigan. All of the crew were experienced men. The contract price for pulling, cleaning, and tipping the stumps on this tract was \$788, or about 32 cts. per stump. The actual cost was 26 cts. The average farmer or settler, even though he had the equipment, probably could not do the work as cheaply as it was done by this contractor.

Tract No. 8 contained 30 acres of nearly level land with sandy-loam soil. The outfit used was a tripod stump puller. The total number of stumps pulled was 2,464. The average number pulled per day was 137. The average number per acre was about 82. The average diameter per stump was about 24 ins. This work was done under contract at 19 cts. per stump for pulling, cleaning, and tipping. The actual cost was 10.2 cts., as shown below. The low cost of stumping was largely due to the sandy nature of the soil and the fact that the stumping crew was experienced. The stumping was done in the fall. These stumps were to be piled and burned later in the year.

TABLE XXIII

| Item | Total |
|--|----------|
| Pulling, cleaning, and tipping: | |
| 2 men, 18 days each at \$1.75 | \$ 63.00 |
| 2 men with teams, 18 days each at \$4.50 | 162.00 |
| Use of machine, 18 days at \$1.50 | 27.00 |
| Piling and burning (estimated) | 616.00 |
| <hr/> | |
| Total | \$868.00 |
| Average per acre | 28.93 |
| Average per stump | 0.352 |

Tract No. 9 contained 30 acres of nearly level land with sandy-loam soil. The outfit used was a tripod stump puller. The total number of stumps pulled was 2,000. The average number pulled per day was 134. The average number per acre was about 67. The average diameter per stump was about 28 ins. This work was done under contract at 25 cts. per stump for pulling, cleaning, and tipping. The actual cost was 10.5 cts., as shown below.

TABLE XXIV

| Item | Total |
|--|----------|
| Pulling, cleaning, and tipping: | |
| 2 men, 15 days each at \$1.75 | \$ 52.50 |
| 2 men with teams, 15 days each at \$4.50 | 135.00 |
| Use of machine, 15 days at \$1.50 | 22.50 |
| Piling and burning (estimated) | 500.00 |
| <hr/> | |
| Total | \$710.00 |
| Average per acre | 23.67 |
| Average per stump | 0.355 |

This tract was stumped in the summer of 1913. The low cost of stumping was largely due to the sandy nature of the soil and the fact that the stumping crew was experienced. This work was done by the same contractor who stumped tracts Nos. 7 and 8. The stumps were piled and burned later in the year.

Tract No. 10 contained 46 acres of nearly level silt-loam to clay-loam soil. In places the tract was very stony; round cobblestones predominated. The outfit used was a tripod stump puller. This tract had been logged 30 years before. The second growth and logs had been previously removed.

The sizes of 114 white-pine stumps selected at random and measured on this tract were as follows: 12-inch, 1; 18-inch, 2; 20-inch, 8; 22-inch, 7; 24-inch, 22; 26-inch, 9; 28-inch, 10; 30-inch, 12; 32-inch, 17; 34-inch, 9; 36-inch, 10; 38-inch, 1; 40-inch, 3; 42-inch, 1; 44-inch, 1; 48-inch, 1. The average diameter was 28.6 ins. and the average height 36 ins. The total number of stumps pulled was 1,812. The average number pulled per day was 48. The average number per acre was 39. This work was done under contract at 35 cts. per stump for pulling and cleaning. The actual cost of pulling and cleaning was 32 cts. per stump, as shown below.

TABLE XXV

| Item | Total |
|---|-----------|
| Pulling and cleaning stumps: | |
| 2 men, 37 $\frac{3}{4}$ days each at \$1.75 | \$ 132.12 |
| 1 man with team, 37 $\frac{3}{4}$ days at \$4.50 | 169.88 |
| 1 man with 3 horses, 37 $\frac{3}{4}$ days at \$5.85 | 220.84 |
| Use of machine, 37 $\frac{3}{4}$ days at \$1.50 | 56.62 |
| Tipping stumps (estimated at 3 cents each) ... | 54.36 |
| Piling and burning (estimated) | 650.00 |
| Total | \$1283.82 |
| Average per acre | 27.91 |
| Average per stump | 0.71 |

The work was done in June and August by an extensive stumping contractor. The stony ground made digging holes under the roots and cleaning the stumps expensive. The large size of the stumps made their

removal costly. The stumps were to be piled later in the year by the use of a log jammer.

Tract No. 11. The operation on tract No. 11 consisted of pulling 1,319 large white-pine and scattering hardwood stumps on silt-loam to clay-loam soil. In places this tract was very stony. The outfit was a tripod stump puller, the same as that used for tract No. 10, which was adjacent. It had been logged 30 years before. All the second growth and logs had been removed. The average size of the stumps was slightly larger than those on tract No. 10. The average number of stumps pulled per day was 37, and the cost was as follows:

TABLE XXVI

| | Total |
|---|-----------|
| Pulling and cleaning stumps: | |
| 2 men, 35.6 days each at \$1.75 | \$ 124.50 |
| 1 man with team, 35.6 days at \$4.50 | 160.20 |
| 1 man with 3 horses, 35.6 days at \$5.85 | 208.26 |
| Use of stump puller, 35.6 days at \$1.50 | 53.40 |
| Dynamite (40 per cent strength), 500 pounds, at 13 cents | 65.00 |
| Caps and fuse | 2.51 |
| Piling and burning (estimated) | 450.00 |
| | <hr/> |
| Total | \$1063.87 |
| Average per stump | 0.806 |

The time of stumping was August and September, 1913. A small charge of dynamite was placed under the larger stumps in order to split and loosen them. In commenting on the use of dynamite here, the contractor said: "This is the only job in my seven years of stumping where it would pay to use dynamite under nearly every stump." The owner of this tract had previously used dynamite in stumping on his land.

Tract No. 12 contained 40 acres of nearly level land with sandy-loam soil. The outfit was the same as for tract No. 11. The total number of stumps pulled was 2,400. The total number of stumps per acre was 60. The average number of stumps pulled per day was 100. *The stumps averaged somewhat smaller than in the two preceding tracts,* and the soil was sandy loam and free from stones. This work was done in the spring at a

contract price of 18 cts. per stump for pulling, cleaning, and tipping. The actual cost was 14 cts. per stump, as shown below:

TABLE XXVII

| | Total |
|--|----------|
| Pulling, cleaning, and tipping stumps: | |
| 2 men, 24 days each at \$1.75 | \$ 84.00 |
| 2 men with teams, 24 days each at \$4.50 | 216.00 |
| Use of machine, 24 days at \$1.50 | 36.00 |
| Piling and burning (estimated) | 432.00 |
| | <hr/> |
| Total | \$768.00 |
| Average per acre | 19.20 |
| Average per stump | .32 |

Tract No. 13 contained 20 acres of practically level pasture land having a sandy, and in places a gravelly, surface soil. The subsoil was generally below root depth. This land had been logged 25 years before. There were no logs or underbrush. The outfit used was a tripod stump puller.

Stumps to the number of 1,293 were pulled, piled, and burned at a contract price of \$500, or 38.7 cts. per stump. By means of the tripod piler shown in Fig. 63 all these stumps were put into four piles. The stumps were pulled in November, 1912.

The sizes of 98 white-pine stumps selected at random and measured on this tract were as follows: 12-inch, 6; 14-inch, 8; 16-inch, 8; 18-inch, 5; 20-inch, 10; 22-inch, 16; 24-inch, 16; 26-inch, 11; 28-inch, 5; 30-inch, 8; 32-inch, 2; 34-inch, 1; 38-inch, 2. The average diameter was 23.2 ins.

Several other owners in this neighborhood had contracted to have stumps pulled, cleaned, and tipped for 25 cts. each. The general clearing conditions on these contracts were the same as for tract No. 10.

Tract No. 14 contained 7.4 acres of very gently rolling pasture land, having a loose, sandy-loam soil. The outfit used was a tripod machine mounted on two wheels. This tract had been logged 45 years before. There were no logs or underbrush.

The sizes of 98 white-pine stumps selected at random and measured on this tract were as follows: 16-in

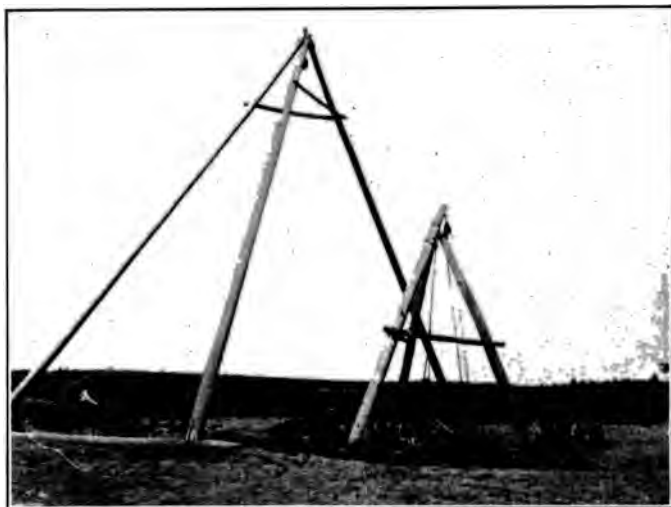

Fig. 63. Tripod Stump Piler (Left). Tripod Stump Puller (Right)

7; 18-inch, 10; 20-inch, 3; 22-inch, 9; 24-inch, 15; 26-inch, 14; 28-inch, 8; 30-inch, 6; 32-inch, 7; 34-inch, 4; 36-inch, 6; 38-inch, 3; 40-inch, 1; 42-inch, 4; 48-inch, 1. The average diameter was 26.77 ins.

The high cost of stumping this tract was principally due to the inexperience of the contractor and crew and to the fact that only one light team was used. The contract price for pulling, cleaning, and tipping the stumps was 50 cts. each. The actual cost was 56.3 cts. The owner of the tract was utilizing the roots for fuel. The total number of stumps was 204 and the number per acre 28. The number pulled per day was 15. Work was done in July and August, 1913.

TABLE XXVIII

| Item | Total |
|--|----------|
| <i>Pulling, cleaning, and tipping:</i> | |
| 1 boy, 13¼ days at \$1.00 | \$ 13.25 |
| 1 man, 13¼ days at \$1.75 | \$ 22.19 |

| Item | Total |
|---|----------|
| 1 man with team, 13¼ days at \$4.50 | \$59.62 |
| Use of machine, 13¼ days at \$1.50 | 19.87 |
| Piling and burning (estimated) | 70.00 |
| | <hr/> |
| Total | \$184.93 |
| Average per acre | 25.05 |
| Average per stump | 0.907 |

Tract No. 15 contained 40 acres of very gently rolling land, having a sandy soil. The clearing was done in the spring of 1912. The outfit consisted of a tripod stump puller, two teams, and five men. This outfit and crew pulled 2,132 stumps in 20½ days, an average of 104 stumps per day. This tract had an average of 90 stumps per acre, of which 20 were Norway pine and 70 were white pine.

The clearing was done at a contract price of \$30 an acre. The price included the delivery of the Norway-pine stumps to a turpentine plant 3 miles distant from the tract, the hauling of nearly one-third of the white-pine stumps to build fences, and the burning of the remainder of the white-pine stumps. The Norway-pine stumps had been burned to the surface of the ground on nearly 10 acres of this tract. A total of 60 cords of Norway-pine stumps was delivered at the plant. The price received was \$5 per cord of 4,000 lbs. It took an average of 10 Norway-pine stumps to the cord. Two cords of stumps per acre were obtained. After deducting the amount received for the stumps, the net cost of clearing the tract was \$900, or \$22.50 per acre. The contractor still considers \$30 a fair price, but owing to circumstances and bad weather wages were not made upon this work.

In another case in this neighborhood the owner of 640 acres of land gave all the Norway-pine stumps on it for the clearing of 15 acres ready for the plow.

Tract No. 16. On a tract of 35 acres of nearly level land, having a sandy-loam surface soil and a clay sub-soil, which had been logged 30 years before, 1,050 white-pine stumps, averaging 26 ins. in diameter, were pulled with a tripod machine at a contract price of 33⅓ cts per stump for pulling, cleaning, and tipping.

Tract No. 17. On another tract of 105 acres of nearly level land, having a sandy-loam surface soil and a clay subsoil averaging 18 ins. below the surface, which had been logged 25 to 40 years before, 7,000 white-pine stumps, averaging 22 ins. in diameter, were pulled with a tripod machine at a contract price of 25 cts. per stump for pulling, cleaning, and tipping. These stumps were hauled into fence rows for 18 cts. per stump, contract price.

Tract No. 18. On a tract of 10 acres of gently rolling land having a sandy and gravelly loam surface soil and in places a clay subsoil, which had been logged 25 years before, 600 white-pine stumps, averaging 18 ins. in diameter, were pulled with a tripod machine at a contract price of 30 cts. each for pulling, cleaning, and tipping.

Tract No. 19. On an adjoining tract of 16 acres, with soil the same as in tract No. 18, and using the same outfit, 330 stumps were pulled, cleaned, and tipped for 30 cts. each. The contractor took both jobs at a flat rate of 30 cts. per stump.

Tract No. 20 contained 18 acres of cedar-swamp land that had been very severely burned in 1908 and 1911. The soil varied from a clay loam to a heavy clay. Practically all the roots had been burned off. The stumps rested on top of the ground. One horse could easily pull nearly every stump on this tract. The few stumps that were too firmly rooted to be pulled by a horse were loosened by the use of dynamite. The number of trees and stumps per acre on adjoining similar tracts was about 300. The stumping and part of the piling was done from July 15 to October 1, 1912. The remainder of the piling and all of the burning was done after April 12, 1913. The work of clearing was thorough. The details of cost are as follows:

TABLE XXIX

| | Total |
|--|--------------|
| Stumping and piling: | |
| 1 man as laborer and driver, 60 days at \$1.75 | \$105.00 |
| 1 man as laborer and powder man, 60 days at \$1.75 | 105.00 |
| 1 horse, 60 days at \$1.25 | <u>75.00</u> |

| | Total |
|--|----------|
| Total labor cost | \$285.00 |
| Dynamite (40 per cent strength), 50 pounds, at 20 cents | 10.00 |
| Fuse and caps | 0.75 |
| Burning stumps and completing clearing: | |
| 1 man, 18 days at \$1.75 | 31.50 |
| 1 man with team, 18 days at \$4.25 | 76.50 |
| | <hr/> |
| Total | 403.75 |
| Average cost per acre | 22.43 |

This swamp clearing is typical of the cost of clearing much of the severely burned swamp land of Cheboygan and Presque Isle Counties, Mich.

Disposal of stumps after pulling. Where medium-sized stumps have been well blasted the problem of stump disposal is relatively simple. It is considered cheaper to start several small, conveniently located fires in the holes made by blasting the stumps and then haul the remaining pieces to these fires than it is to build a few large piles and not set them on fire until all the stumps are piled. Where the stumps have been pulled by a stump puller without the use of powder the problem of disposal is more difficult. The general opinion throughout this region is that the cost of disposal practically equals the expense of pulling. All data secured seem to verify the accuracy of this estimate. In the early days of clearing, the stumps were hauled into rows to serve as fences. At the present time very few such fences are being built. The usual contract price for hauling stumps into fences is 15 to 18 cts. each.

Piling stumps. Large stumps are very hard to pile. Some owners split the stumps by the use of a small charge of dynamite placed either in a hole bored into the base of the stump or in a notch chopped between two prominent roots. Often the heart of the stump is sufficiently decayed so that the charge may be placed in it. A small quantity of dynamite used in this manner will usually split the stump as well as a much larger charge would have done before the stump was pulled.

By using a tripod, such as is shown in Fig. 63, with logs 40 or 45 ft. long and equipped with a double block

and 150 ft. of half-inch cable, the stumps can be piled 25 or 30 ft. high. This tripod was used on tract No. 13. Another good method of piling is to use a piler with a swinging boom, as shown in Fig. 62. The mast of this piler is 30 ft. high and the swinging boom 25 ft. long. In using this boom piler the mast is set so that it leans slightly toward the pile. This causes the boom to swing to the center each time. This piler was used in clearing tract No. 5. Dropping stumps into a fire by means of piling devices is impracticable, because the heat soon becomes so intense that the piling operations must be abandoned.

The work of piling stumps could be hastened materially if some satisfactory tripping device could be used. The usual self-tripping tongs and rope trips frequently catch on projecting roots and drop the load before it is at the desired position.

Other ways of disposing of stumps. In the past a considerable number of Norway-pine stumps have been used by turpentine manufacturers for distillation. The present low price of turpentine and naval stores has made the distillation of Norway-pine stumps unprofitable, and none of the turpentine plants are now in operation. The white-pine stump contains too small a quantity of the properties of the Norway-pine stump to make it of any value.

Summary and suggestions. There are approximately 11,954,628 acres of logged-off land in Michigan, 10,792,100 acres in Wisconsin, and 11,768,000 acres in Minnesota. A large part of this area will make good agricultural land if cleared and properly managed. In many localities poor methods make the clearing of this land unprofitable. Cutting and burning the second growth pasturing for several years, and keeping down all sprout growth is the most economical method of handling all logged-off lands before stumping them. Explosives play an important part in clearing land. On the heavier soils dynamite, with 20 to 30 per cent of nitroglycerin or its equivalent, is to be preferred. Cooperative buying in large quantities is recommended. Stump pullers reduce the cost of stumping on lighter

soils. On the heavier soils the difference between the cost of clearing by explosives and by the use of stump pullers is very slight.

The cost of clearing the better grade of white-pine logged-off land will average \$10 per acre for disposing of the brush and \$25 to \$30 per acre for disposing of the stumps, making the cost of clearing \$35 to \$40 per acre. Some green hardwood lands and unburned swamp lands will cost as much as \$100 per acre. Some of the poorer jack-pine lands can be cleared for \$5 per acre or less. The cost of disposing of the stumps after pulling practically equals the cost of pulling. A tripod or a boom piler is recommended to facilitate piling and burning.

The settler with little capital and without experience who expects to make a farm out of a tract of logged-off land will find his problem a most trying one. The experiences of those who have attempted it are not encouraging. The man who starts farming with even 10 acres of his farm cleared will be much more likely to succeed than the man who begins on a tract covered with second growth and stumps. The former will have land on which to grow hay and other crops the first year. He can devote his extra time the first three or four years to the disposal of the second growth on the remainder of his tract. By seeding this, he will increase the area of his pasture or hay land materially and will be employing the best preparatory means of reducing the cost of stumping later. The settler should not forget that the cheapest and best land clearing is always done by experienced men with proper equipment.

For these reasons it is recommended that, in all localities where land companies are selling lands to settlers, no tract of land be sold unless it contains at least 10 acres of land cleared ready for the plow.

CHAPTER VIII

HEAVY PLOWS

Heavy plows. Heavy plows pulled by traction engines have been used with success in clearing away brush and stumps of small trees. They will cut all roots below the ordinary plowing depth but considerable hand labor will be necessary to gather and remove them. Raking machines might be devised for gathering the roots. Two plows made by the Avery Co., of Peoria, Illinois, are here illustrated.

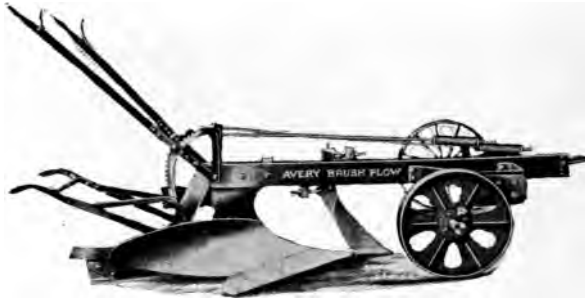

Fig. 64. Avery Brush Plow

Fig. 64 shows one of these plows, which in connection with the Avery "Light-Weight" 12-25 and 18-36 H. P. Tractors, is being used quite extensively in the Northwest for bringing brush land and land covered with poplar trees under cultivation at a low cost per acre. Price, \$140 cash.

Fig. 65 shows a plow especially designed for plowing *mesquite and chaparral* in Southern Texas and Gulf Coast territory. Each plow has a share that cuts full 30 inches, but the plows are so set that the furrow slice

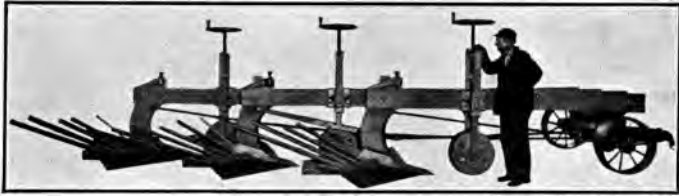

Fig. 65. Avery Bull Dog Grub Plow

is only 24 inches wide, leaving the balance of the share to cut under the previous furrows, and thereby cut off any roots that may be left.

Numerous attempts have been made to construct a plow to meet the requirements of this class of work, but they have all been too light and would not stand the strain. This machine weighs 10,000 pounds and is very strongly built.

A wheel gauge is provided so that in hog-wallow land the depth of plow can be regulated to follow the uneven surface, turning a furrow at a uniform depth.

The plows are set 5 feet ahead of each other, giving ample space for brush to clear. The plow standard is of cast steel and the points are reversible, adjustable, and renewable, and independent of the share. The beams are made of two pieces of $1\frac{1}{2}$ -inch high carbon steel, 8 inches wide, and each plow has a draft rod running direct through to the hitch under the fore carriage of the engine.

The beam standards are provided with set screw adjustment and slotted holes for adjusting the suck of the plows.

In place of moldboards, $1\frac{1}{2}$ -inch square bars are provided, thus the question of cleaning or scouring is eliminated.

In view of the extraordinary weight, raising and lowering and manipulating the plows by hand levers have been found to be impracticable and thus a hand wheel and screw adjustment lifting device for each plow has been provided. Thus it will be seen that each plow is *lifted and the depth regulated independently of the others.* Price, \$933.

Clearing land by plowing. *Engineering and Contracting*, Aug. 21, 1912, gives the following:

Clearing an area of scrub oak and hazel-brush patches is being accomplished near Dennison, Ia., by means of a 45-h. p. gasoline tractor and a large plow made by the International Harvester Co. The engine burns kerosene oil and consumes approximately 20 gals. of kerosene a day, costing 7 cts. a gal. It requires two men for the operation, one on the engine and one on the plow. This outfit plows along through the stiff brush and saplings at the rate of 2 to 2½ miles an hour. Trees and roots 3 ins. thick are easily cut off, and the whole is turned under a foot of sod. The outfit plows a furrow 24 ins. wide and 12 ins. deep. The large plow being used to turn under hazel-brush and shrubbery is known as the grub breaker, size 24 ins., heavy steel beam, using a standing coulter. The plow is mounted on a two-wheel truck and is regulated by levers. The weight of the plow is about 1,300 lbs. From 4 to 5 acres are covered per day.

Clearing brush with a caterpillar tractor. The illustration (Fig. 66) shows a caterpillar tractor fitted with

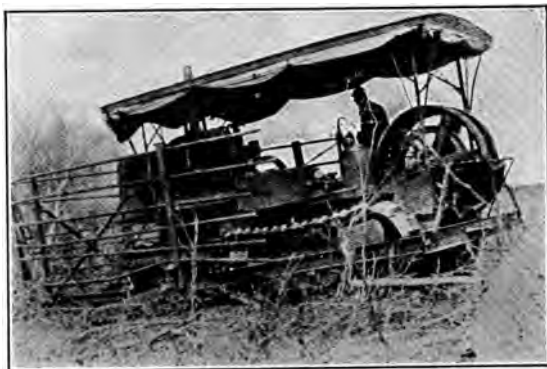

Fig. 66. Holt Caterpillar Tractor with Brush Cutting Device
a brush cutting device for clearing land, for farming, irrigation, reservoir, road or other work requiring removal of not too large growths. With the equipment

shown a swath 16 ft. wide was cleared at a rate of 2 miles per hour. The pointed framework attached to the front of the machine has at the bottom two long, sharp knives. These knives run close to the ground and cut the brush close to the surface while the frame above throws the cut brush aside in windrows. It is stated that saplings up to 8 in. in diameter have been cut. Another attachment, which can be used where grubbing needs to follow clearing, is the plow shown by Fig. 67 and first developed for grubbing grape vine roots by the

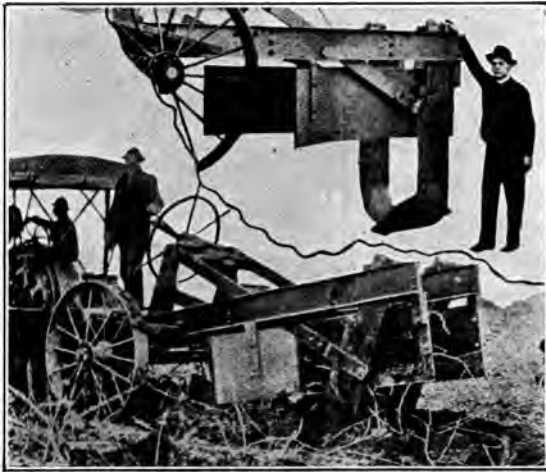

Fig. 67. U-Shaped Root Cutter

Killefer Mfg. Co., Los Angeles, for the Stanford Vina Ranch. As indicated the plow is simply a big U-forging which goes down any depth desired, from one-half an inch to 30 in. into the ground and cuts off the roots, the depth being regulated by a simple screw and hand-wheel. At 24 in. depth the plow has cut roots 8 in. in diameter. The puller weighs 7,000 lb. It is 15 ft. long, over all; 7 to 10 ft. high. The main members of the frame are 12-in. I-beams. In the bottom of the U-forging is a sharp-edged shoe or plate which cuts the main roots of the vines. Two wing plates are fasten

to the upper half of the U to guide it centrally under the vines. The caterpillar tractor used was made by the Holt Manufacturing Co., Stockton, Cal., and Peoria, Ill.

Clearing sage brush in Silver Lake District, Ore.

John T. Whisler and John H. Lewis in a report on the Silver Lake Project in Oregon, October, 1915, under a discussion of agricultural conditions give the following data:

From information obtained from farmers, we find that the average cost of clearing on twelve farms was \$4.50 per acre. In one instance clearing was being done with a homemade sage grubber, consisting of a heavy sled with heavy knives extending out diagonally on either side of the runners. The sled was drawn by a traction engine and the brush piled on the sled to use for fuel in plowing. It was estimated that an acre could be cleared by this method in one hour when working steadily. The tool left the soil loose as though it had been disked.

The following is a list of manufacturers of supplies and equipment for use in Clearing and Grubbing:

Etna Powder Company, Chicago, Ill.
Bennet & Co., H. L., Westerville, Ohio.
Butterworth & Lowe, Inc., Grand Rapids, Mich.
Clyde Iron Works, Duluth, Minn.
Cutaway Harrow Co., The, 3924 Main St., Higganum, Conn.
Du Pont Powder Co., Wilmington, Del.
Faultless Stump Puller Co., R. S. Caward, Pres., Cresco, Iowa.
Foundry Motor Car & Mfg. Co., Inc., St. Albans, Vt.
K Hand Power Stump Puller, 182 5th St., San Francisco, Cal.
Kansas City Hay Press Co., Kansas City, Mo.
Kirstin Co., A. J., 6041 Ludington St., Escanaba, Mich.
Milne Manufacturing Co., Monmouth, Ill.
Smith Grubber Co., W., La Crosse, Wis.
Swenson Grubber Company, Cresco, Iowa.
Zimmerman Steel Company, Lone Tree, Iowa.

INDEX

| | | | |
|--|-----|--|-----|
| Age, effect on stumps | 7 | Boring, by power | 85 |
| Age of stumps, effect on burning | 82 | By power driven outfit | 111 |
| Anchor stump | 148 | Cost with machine | 114 |
| Apple trees | 62 | Machine | 69 |
| Grubbing by hand | 62 | Outfit cost | 115 |
| Appraisal of clearing and grubbing | 16 | Boulders, hitch for remov- ing | 154 |
| Area cleared, how consti- tuted | 23 | Box for carrying explo- sives | 93 |
| Arrangement of hitches | 172 | British Columbia, clearing and grubbing a dam site | 56 |
| Ash, rapid decay of stumps | 7 | Brush, cut with special de- vice hauled by a tractor | 230 |
| Roots | 6 | Grubbed by plowing | 230 |
| Assembling timber, cost per acre | 43 | Hooks | 37 |
| Auger | 93 | Brushing, cost per acre | 42 |
| Avery brush plow | 228 | Brutting | 1 |
| Axes | 37 | Bucker | 1 |
| Bar for locating roots | 109 | Bucking, cost 200, | 203 |
| Barking | 1 | Cost per acre | 57 |
| Big tree stumps, method of blasting | 108 | Definition of | 1 |
| Blasting | 92 | Bull cook | 1 |
| As an aid to pulling | 169 | Burner, experiment with | 79 |
| Charge | 51 | Burning | 50 |
| Cost 116, 132, 202, 203, | 212 | And char-pitting | 68 |
| Cost at Oyster Bay, Long Island | 131 | Boring holes for | 68 |
| Cost in Kentucky | 123 | Conclusions on use of blowing machine | 88 |
| Cost in New Jersey | 122 | Cost | 214 |
| Cost of blasting bored stumps | 115 | Cost of blower 78, | 84 |
| Cost on Long Island | 117 | Stumps | 171 |
| Efficiency | 47 | Stumps around gin pole | 178 |
| Blower, cost of using | 78 | Stumps piled with der- rick | 192 |
| Blowing machine, burning logs | 81 | With blowing machine | 80 |
| Cost | 78 | Burning brush, cost per acre | 42 |
| Experiment with | 79 | Burning stumps, efficiency of char-pitting method | 79 |
| For stump burning | 76 | | |

- Cable, for pulling with machine 176, 186
- Cap crimpers 93
- Caps, care in handling .. 97
- Capstan, horse power puller 144
- Stump puller 208
- Catalpa, durability of stumps 7
- Cedar, durability of cedar stumps 7
- Method of blasting 107
- Stumps destroyed by blowing machine 81
- Chains, for use with pullers 157, 161
- Charge, locating 102
- Char-pitting, at Globe, Ore. 74
- Conclusions 73
- Cost 73
- Efficiency of. 72
- Stumps 70
- Chaser 1
- Chestnut, durability of stumps 7
- Roots 6
- Choker 1, 177, 179
- Self releasing 179
- Clearing, definition of... 1
- Clyde Iron Works, stump pulling machine 184
- Clutch hand stump puller 141
- Cone, for use in log skidding 165
- Contract prices for clearing and grubbing 16
- Corduroy roads 57
- Cordwood, cost 118
- Cost of cutting 58
- Cost of piling 43
- Rate of cutting 58
- Splitting cost 43
- Value 43
- Cost, effect of method of excavation on 12
- Factors in 5
- Cracking stumps for pulling 169
- Crops following clearing .. 63*
- Traw-bar 93*
- Cutaway harrow 52
- Cutting machine for stumps 189
- Cypress, method of blasting stumps 105
- Daily report form 132
- Dam, clearing for dam in Oklahoma 66
- Specifications for clearing and grubbing for 28
- Deadening 1
- Derrick for piling stumps 192, 215
- Directory of Mfgs. 233
- Disposal of stumps after pulling 225
- Distillation of Norway pine stumps 226
- Distilling stumps in place 89
- Dogwood roots 7
- Donkey engine, cost .. 181, 182
- Estimate and specifications 181
- Method of clearing 175
- Operating speed 181
- Suggested improvements 178
- Douglas fir, cost of grubbing 196
- Drum, hand stump puller 141
- Dynamite, amount required 106
- Amount used in successful blasting 109
- Method of handling ... 95
- Properties of 92
- Used for topping spar tree 178
- Electric blasting machine 99
- Electric firing 100
- Elevated grader work, cost of grubbing for 13
- Grubbing for 63
- Elm, roots 7
- Estimating, shrinkage ... 14
- Small tracts of standing timber 16
- Excavation, effect of various methods on cost of grubbing 12

- Loss due to removal of stumps 15
- Explosive, amount required 106
- Grade for use with tap rooted stumps 115
- Explosive, kinds used in Wisconsin 92
- Method of handling dynamite 95
- Factors effecting cost of clearing and grubbing 209
- Faller 2
- Falling, cost 200
- Cost per acre 57
- Definition of 2
- Felling, definition of 2
- Fence posts, value 43
- Fences, use of stumps for 223, 224
- Fir, amount of dynamite used for blasting stumps 110
- Cost of grubbing Douglas fir 196
- Method of blasting 107
- Stumps destroyed by blowing machine .. 78, 81
- Weight of 58
- Firing, charges 99
- Electric 100
- Florida, cost of clearing road at Palatka 18
- Flunkey 2
- Frost, an aid in grubbing 61
- Fruit tree, roots 6
- Fuse 95
- Gin pole 176
- Used grubbing Douglas fir 196
- Girdling 1
- Glossary of terms 1
- Green stumps 102
- Blasting efficiency 47
- Pulling 48
- Grub axes 60
- Grub plow 149
- Grubbing by hand 60
- Definition of 2
- Gum, amount of dynamite used in blasting stumps 110
- Black gum roots 6
- Rapid decay of stumps 7
- Hackberry blasting in Kentucky 126
- Hand grubbing aided by frost 61
- Cost 116
- Heavy plows 228
- Hemlock, amount of dynamite used in blasting stumps 110
- Rapid decay of stumps 7
- Roots 7
- Hickory, rapid decay of stumps 7
- Roots 6
- Highway, clearing in Oregon 134
- Specifications for clearing and grubbing for 25
- Hints on placing charges 96
- Hitches, arrangement of multiple power 171
- Hitching to stumps 151
- Home-made horse stumps piler 199
- Horse power stump pullers 142, 145
- Hubbard stump burner ... 89
- Improvements in donkey engine outfit 178
- Interstate Commerce Commission's valuation of clearing and grubbing 18
- Judson powder 122
- Kentucky, cost of blasting ing stumps in 123
- Knees, for ship building 150
- Lake States, costs and methods of clearing land

- and clearing practice . . . 35
 and, extent of, logged off
 in Washington 173
 Lateral rooted stumps . . . 102
 Lateral roots 7
 Law, decision of court in
 clearing and grub-
 bing 24
 Legal decision relating to
 clearing and grub-
 bing 24
 Loading holes 97
 Locating charge 101
 Locomotive crane pulling
 stumps 165
 Locust, durability of lo-
 cust stumps 7
 Roots 7
 Logging, cost per acre . . . 42
 Logs, — burning with
 blower 81
 Cost of piling 43
 Cost of skidding 43
 Cost of rolling and burn-
 ing 57
 Piling with pile driver . . 166
 Rig for skidding 164

 Machetes 37
 Man power stump pullers 138
 Maple, amount of dynamite
 used in blasting
 stumps 111
 Soft maple roots 7
 Marion log loader 167
 Maryland, cost of clearing
 reservoir 116
 Massachusetts, cost of
 clearing Spot Pond
 Reservoir 62
 Cost at Springfield . . . 197
 Material lost through grub-
 bing 14
 Mattocks 60
 McEwen patented cone . . . 165
 McGiffert log loader 166
*Minnesota, cost of clear-
 ing in* 39
Cost of stumping 131
isfires 101

 Moving houses with stump
 puller 151
 New Jersey, cost of blast-
 ing 1,100 stumps 122
 New York, blasting 3,500
 stumps on Long Is-
 land 119
 Clearing on Long Island 130
 Cost of clearing a reser-
 voir at Indian River . . . 54
 Grubbing reservoir site 128
 Norway pine, cost 223
 Notching 2

 Oak, amount of dynamite
 used for blasting
 stumps 110
 Blasting in Kentucky . . 124
 Cost of blasting white
 oak 116
 Durability of stump . . . 7
 White oak roots 6
 Oak stumps, burning 75
 Ohio, cost of clearing reser-
 voir 194
 Oklahoma, clearing for
 earth dam 66
 Old logs, cost of blasting 203
 Old stumps, burning 82
 Ontario, bidding prices for
 clearing land 54
 Oregon, char - pitting
 stumps at Globe, Ore. 74
 Clearing sage brush with
 tractor 232
 Cost by various methods 182
 Cost of clearing for
 highway 134
 Osage orange, blasting in
 Kentucky 126

 Paying for clearing and
 grubbing, methods of 20
 Paying, system of 27
 Payment for clearing and
 grubbing 23
 Persimmon, roots 6
 Pile driver 166
 Piler, home-made 199
 Piling, by donkey engine 175
 Cost 198, 216

- Stumps 49, 171, 225
 Stumps with derrick ... 214
 Use of choker 177
 With derrick 192
 With tripod piler 221
 Piling and burning, cost 133
 Pine, amount of dynamite used for blasting stumps 109
 Blasting in Kentucky 124
 Boring stumps with power drill 112
 Cost of blasting 116
 Cost of grubbing Norway pine stumps ... 223
 Cost of removing white pine stumps 221, 212
 Cost pulling white pine 217
 Distilling stumps in place 89
 Durability of pine stumps 7
 Method of blasting ... 107
 White pine roots 6
 Yellow pine roots 6
 Pioneer land clearing machine 188
 Plowing, brush 230
 With caterpillar tractor 230
 Plows, heavy 228
 Pole wood, cost cutting .. 43
 Poplar, rapid decay of stumps 7
 Roots 6
 Power driven outfit for boring 111
 Power hitches, arrangement of 171
 Power puller 208
 Power pulleys 168
 Puller, Capstan 208
 Power 208
 Tripod 208
 Pulling, at Springfield, Mass. 197
 By donkey engine 175
 Cost 182, 198, 202, 212, 213
 Cost with team 216
 Cost with tripod machine 217, 218
 Force and speed of machine 186
 On reservoir site in West Virginia 158
 Small trees with traction engines 205
 Pulling stumps 168
 Cost with man power machine 139
 Time per acre 48
 With locomotive crane . 165
 Railroad right of way, cost of clearing 200
 Specifications for clearing and grubbing of 32
 Ranking 2
 Redwood, method of blasting 108
 Reservoir, clearing a site in West Virginia ... 158
 Clearing for reservoir in Massachusetts 62
 Cost of clearing in Maryland 116
 Cost of clearing in Ohio 194
 Grubbing Kensico Reservoir, N. Y. 128
 Specifications for clearing and grubbing for 28
 Rig for log skidding ... 164
 Rigging, slinger 2
 Stump pullers 143
 Road, specifications of clearing and grubbing for 24
 Roots, lateral 7
 Semi-tap 6
 Tap 6
 Types of 6
 Rossing 1
 Rotary stump cutting machine 189
 Sage brush, cost of clearing with a tractor .. 232
 Sassafras, roots 6
 Sawing, relative rate of .. 5
 Sealing 1
 Scraper work, cost of grubbing for .. 1

- = iota River reservoir ... 194
- > eding 52
- In Washington 174
- Self-releasing choker 180
- Semi-tap rooted stumps .. 102
- Shovel 93
- Shrinkage, due to grubbing 14
- Single trees 61
- Skidding 2
- Rig for 164
- Speed of Clyde Iron Works machine 186
- Skidding logs, cost of... 43
- Skid roads 57
- Slack rope, clutch for taking up 153
- Slashing 2
- Cost 202, 203
- Small trees, method of pulling 151
- Pulled with traction engine 205
- Pulling 154
- Snags 213
- Snaking 2
- Sniping 2
- Spar tree 178
- Specifications, criticism of 19
- For clearing and grubbing for an earth dam at McAlester, Okla. . 29
- For clearing and grubbing on railroad work 32
- For various water works projects 28, 29
- Main dam Ashokan Reservoir 31
- Reservoir and dam 28
- Road 24
- Speed, of donkey engine outfit 181
- Of pulling with Clyde Iron Works machine 186
- Spruce, amount of dynamite used for blasting stumps 110
- Stumps 174
- Estimating timber, estimating* 16
- in land clearing machine* 187, 190
- Steam shovel work, cost of grubbing for 13
- Stripping, specifications for 28, 30
- Stumping 2
- Powder 2
- Stump burner 75, 89
- Blowing machine for stump burning 76
- Stump puller, Boyle's... 154
- Clyde Iron Works machine 184
- Large base 146
- Small base 145
- Sweep 155, 159
- Tripod 162
- Stump pullers, capacity .. 137
- Cost 137
- Horse power 142, 145
- Man power 138
- Rigging 143
- Stumps, burning 68
- Char-pitting 70
- Cost of burning with a blower 78
- Cost of piling 49
- Destroying with blower 77
- Effect of age on 7
- Loss in excavation due to removal of 15
- Method for hitching stump puller 151
- Sub-soil, relation of explosive to 98
- Swamping 2
- Cost 200
- Cost per acre 57
- Sweep stump puller .. 155, 159
- Take ups 149, 168
- Topping spar tree 178
- Tap-root pine, amount of dynamite used in blasting 111
- Tap-rooted stumps 102
- Tap root stumps, boring with power drill 112
- Tap roots 8
- Terms, glossary of 1

| | | | |
|---|----------|--|-------|
| Texas, cost of clearing with pulling machine | 187 | Distilling Norway pine | 226 |
| Tongs for use with piling derrick | 193 | Distilling stumps in place | 89 |
| Tools, auger | 93 | U-shaped root cutter | 231 |
| Axes | 37 | Valuation of clearing and grubbing by Interstate Commerce Commission | 18 |
| Bar for locating roots .. | 109 | Virite, properties of | 92 |
| Brush hooks | 37 | Walnut, amount of dynamite used in blasting stumps | 110 |
| Cap crimper | 93 | Roots | 6 |
| Crow-bar | 93 | Washington, acres of logged off land | 10 |
| Cutaway harrow | 52 | Cost of various methods | 182 |
| Electric blasting machine | 99 | Project | 57 |
| Grub axes | 60 | Extent of logged off land | 173 |
| Machetes | 37 | Weeds, destroyed with harrow | 195 |
| Mattocks | 60 | Weighted diameter | 9, 11 |
| Shovel | 93 | West Virginia, removing stumps from a reservoir site | 158 |
| Supply box | 93 | Wet logs, burning | 81 |
| Wooden ramrod | 93 | Willow, method of blasting stumps | 105 |
| Traction engine, pulling small trees | 205 | Yarding | 2 |
| Used for clearing sage brush | 232 | Cost | 200 |
| Used for plowing out brush | 230 | | |
| Trees, number per acre ... | 8 | | |
| Tripod, stump piler | 221 | | |
| Tripod stump puller, 162, | 208 | | |
| Cost | 164 | | |
| Cost of using | 218, 219 | | |
| Turpentine recovery, machine for cutting stumps | 189 | | |

LAND OWNERS

Reclaim Your Waste Land.



If you have:
STUMPS to remove,
BOULDERS to remove or
shatter,
TREES to fell or to plant,
SWAMPS to drain, or
ANY idle or worn-out land to
reclaim,

There is a Hercules Explosive to do the work. Hercules Service goes with all Hercules Explosives.

Dynamite

is no longer an agricultural experiment. Its usefulness and practicability on farm or ranch is thoroughly established by many thousands of successful users.

The Scarcity of Labor

is the enemy of progress in agriculture. The practical and economical solution of this difficulty is the use of Hercules Dynamite, "the new farm hand."

Write for information and prices.

"PROGRESSIVE CULTIVATION" is the title of our complete manual on the many uses of Dynamite on the farm. Copy sent free on request to our nearest office.

HERCULES



POWDER

HERCULES POWDER CO.

Wilmington, Delaware

HERCULES



POWDER

Chicago, Ill.
Denver, Colo.
Hazleton, Pa.
Joplin, Mo.
New York, N. Y.

Pittsburg, Kans.
Pittsburgh, Pa.
Salt Lake City, Utah.
San Francisco, Cal.
St. Louis, Mo.

Subsidiary: HERCULES POWDER SALES CO.

KNOXVILLE, TENN. MEMPHIS, TENN.

ENGINEERING AND TECHNICAL BOOKS

The Clark Book Co., Inc., will be pleased to send you any of the following books or sets of books for ten days' examination,

PREPAID AND WITHOUT OBLIGATION

(Reference or membership in engineering society required, or in lieu of this a check for the amount involved, which will not be deposited, or cashed unless you purchase the books. Otherwise the check will be returned to you when you return the books in undamaged condition.)

COMPLETE SETS AT REDUCED PRICES

may be had on terms of \$3 down and \$3 per month. In addition to the sets noted below, we will be glad to quote special discounts on any combination of three or more books desired.

COSTS AND EQUIPMENT

| | |
|--|---------|
| Gillette's—"Cost Data" (All civil engineering) | \$ 5.00 |
| Gillette's—"Handbook of Rock Excavation, Methods and Cost" | 5.00 |
| Gillette's—"Handbook of Earth Excavation, Methods and Cost," Ready in Jan., 1917 | 5.00 |
| Dana's—"Handbook of Construction Plant" | 5.00 |
| Gillette & Dana—"Cost Keeping and Management Engineering" | 3.50 |

STRUCTURAL ENGINEERING

| | |
|--|------|
| Kirkham—"Structural Engineering" | 5.00 |
| Malcoln—"Graphic Statics" | 3.00 |
| Steinman—"Melan's Steel Arches and Suspension Bridges" | 3.00 |
| Tyrrell—"Mill Buildings" | 4.00 |
| Tyrrell—"Artistic Bridge Design" | 3.00 |
| Wells—"Steel Bridge Designing" | 2.50 |

BUILDING WORK

| | |
|--|------|
| Walker's—"Building Estimator's Reference Book" | 5.00 |
| Gilbreth—"Field System" | 3.00 |
| Gilbreth—"Bricklaying System" | 3.00 |

CONCRETE

| | |
|--|------|
| Cochran—"Inspection of Concrete Construction" | 4.00 |
| Dodge's—"Diagrams for the Design of Reinforced Concrete" | 4.00 |
| Gillette & Hill—"Concrete Construction, Methods and Cost" | 5.00 |
| Heidenreich's—"Engineer's Pocketbook of Reinforced Concrete" | 3.00 |
| Reid—"Concrete and Reinforced Concrete Construction" | 5.00 |
| Reuterdahl—"Theory and Design of Reinforced Concrete Arches" | 2.00 |
| Taylor's—"Practical Cement Testing" | 3.00 |
| Tyrrell—"Concrete Bridges and Culverts" | 3.00 |

RAILWAY WORK

| | |
|--|------|
| Lovell's—"Practical Switchwork" | 1.00 |
| Smith—"Maintenance of Way Standards" | 1.50 |
| Smith—"Standard Turnouts" | 1.00 |
| Kindelan's—"Trackman's Helper," revised by Dana and Trimble. Ready in Oct., 1916 | 2.00 |

MISCELLANEOUS

| | |
|---|------|
| Robinson's—"Military Preparedness and the Engineer" | 1.50 |
| Frye's—"Civil Engineers' Pocketbook" | 5.00 |
| Haring—"Law of Contract" | 4.00 |
| Taylor's—"Surveyor's Handbook" | 2.00 |
| Taylor's—"Backbone of Perspective" | 1.00 |
| Parsons—"Land Drainage" | 1.50 |
| Mayer's Telephone Construction | 3.00 |

COMPLETE SETS

| | |
|--|-------|
| Cost Data, Construction Plant, Cost Keeping | 12.00 |
| Structural Engineering, Graphic Statics, Mill Buildings, Steel Bridge Designing | 12.00 |
| Inspection of Concrete, Gillette & Hill's Concrete Methods and Costs, Reid's Concrete Construction | 12 |

CLARK BOOK CO., INC., 27 William Street, New York City

HANDBOOK OF COST DATA

By Halbert P. Gillette, Consulting Engineer, Mem. Am. Soc. C. E.,
Am. Inst. Mech. Eng.

Handbook binding, 4% x 7 inches\$5.00

Eighteen hundred pages of costs, not prices. Almost every conceivable civil engineering operation, from cement sidewalks to railroad systems, divided as follows:

Subjects

Principles of engineering economics; earth excavation; rock excavation, quarrying and crushing; roads, pavements and walks; stone masonry; concrete and reinforced concrete construction; water works; sewers; timber work; buildings; railways; bridges and culverts; steel and iron construction; engineering and surveys; miscellaneous cost data.

The value of the book lies in the fact that the conditions surrounding each operation on which costs are reported are so completely described that the costs may be accurately translated into terms of the same operation under other conditions.

The sale of this book exceeds, we believe, that of any other engineering work.

Cement Age: "Systems of cost keeping are described in the first part of the book, which contractors will find valuable."

The National Builder: "Mr. Gillette does not seem to have overlooked a single item in the contracting world, where costs and time are factors in making up an estimate."

Railway Age Gazette: "The author was a practicing engineer and contractor for nearly twenty years before he prepared the first edition, so the reader may feel that the book is not the work of an office man."

Canadian Engineer: "It is safe to say that on any question on which the engineer requires costs, they may be found in this book."

THE TRACKMAN'S HELPER

By F. Kindelan

Revised by R. T. Dana and A. F. Trimble

Ready in Oct., 1916

Handbook size and binding\$2.00

Written to help the man on the track, by giving him the results of observation and study of track work on the railroads of the United States for the last twenty years.

Contents: I, Construction; II, Spiking and Gaging; III, General Spring Work; IV, Drainage; V, Summer Track Work; VI, Cutting Weeds; VII, Ballasting; VIII, Renewal of Rails; IX, Effects of the Wave Motion of Rail on Track Rail Movements; X, General Fall Track Work; XI, Fences; XII, General Winter Work; XIII, Bucking Snow; XIV, Laying Out Curves; XV, Elevation of Curves; XVI, Lining Curves; XVII, Mountain Roads; XVIII, Frogs and Switches; XIX, Use and Care of Track Tools; XX, Tie Plates; XXI, Wrecking; XXII, General Instructions; XXIII, Miscellaneous.

HANDBOOK OF EARTH EXCAVATION, METHODS AND COST

By Halbert P. Gillette

Ready Jan. 1, 1917

Handbook size and binding, over 800 pages, illustrated.....\$5.00

A complete history and encyclopedia in modern earth moving methods, with detailed costs for the different methods and equipment used.

Chapters: Properties of Earth, Measurement and Classification, Boring and Sounding, Clearing and Grubbing, Loosening and Shoveling, Wheelbarrows, Carts, Wagons, etc., Scrapers and Graders, Cars, Steam Shovel Work, Bucket Excavation, Cableways and Conveyors, Trenching by Hand, by Machinery, Ditches and Canals, Embankments, Earth Dams and Levees, Dredging, Hydraulic Excavation, Miscellaneous.

CLARK BOOK CO., INC., 27 William Street, New York City

HANDBOOK OF CONSTRUCTION PLANT WITH APPENDIX OF PRINCIPAL MANUFACTURERS

By Richard T. Dana, Consulting Engineer, Mem. Am. Soc. C. E., Mem. A. I. M. E., Mem. Am. Soc. Eng. Contr., Mem. Gillette & Dana, Appraisal Engineers

4 1/4 x 7, Flexible Leather, 700 pages\$5.00
The only complete and impartial "catalogue" of construction equipment in existence.

Engineering Record: "Much valuable data are given as to the cost of operation of certain types of machinery—they furnish practically the first published basis for selecting machinery."

The American City: "Mr. Dana's volume gives the information most necessary to engineers in making estimates of construction costs and in executing plans."

The Excavating Engineer: "Undoubtedly the most complete handbook of construction plant ever published. Every conceivable type of machinery and equipment."

Concrete-Cement Age: "The descriptions include practically every type of equipment, as well as cost data."

Western Engineering: "... an abstract of almost every trade catalogue in existence."

Railway Review: "... presenting between two covers that which the engineer often searches through masses of trade catalogues and stacks of card index files to find."

The National Builder: "Many machines, appliances, methods and contrivances the ordinary contractor knows but little about are here fully described and illustrated."

COST KEEPING AND MANAGEMENT ENGINEERING

By H. P. Gillette, Consulting Engineer, Mem. Am. Soc. C. E., Am. Soc. M. E., and Richard T. Dana, Consulting Engineer, Mem. Am. Soc. C. E., Am. Inst. M. E., Am. Soc. Eng. Contr., Mem. Gillette & Dana, Appraisal Engineers

Cloth, 6 x 9 inches, 350 pages\$3.50

This work is to the construction engineer what Taylor's "Shop Management" and "Principles of Scientific Management" are to the shop foreman and superintendent.

The science of engineering management is just beginning to be recognized, and Gillette and Dana have done much, in this book, to forward and develop it.

Mr. Gillette is the author of the now famous "Handbook of Cost Data," and Mr. Dana is the author of the companion work, "Handbook of Construction Plant." To those familiar with these two books this insures the practical nature of "Cost Keeping and Management Engineering."

Complete Chapter Headings

I, The Ten Laws of Management; II, Rules for Securing Minimum Cost; III, Piece Rate, Bonus and Other Systems of Payment; IV, Measuring the Output of Workmen; V, Cost Keeping; VI, Office Appliances and Methods; VII, Bookkeeping for Small Contractors; VIII, Miscellaneous Cost Report Blanks and Systems of Cost Keeping.

SURVEYORS' HANDBOOK

By T. U. Taylor

Leather, 328 pages, illustrated\$2.00
Describes the instruments, their care and adjustment, and the methods practiced in making surveys of all kinds. Extensive tables are given to facilitate calculations.

Chapter Headings

Chain Surveying; Compass Surveying; Transit Survey; Calculation of Areas; Division of Land; Leveling; Topographic Survey; Railroad Survey; Earthwork; City Surveying; Plotting and Lettering; Government Surveying; Trigonometric Formulas; Tables, etc., etc.

CLARK BOOK CO., INC., 27 William Street, New York City

STRUCTURAL ENGINEERING

By **J. E. Kirkham**, Prof. Civil Engineering, Iowa State College, Consulting Bridge Engineer, Iowa Highway Commission. Formerly Designing Engineer with American Bridge Co.

Cloth, 6 x 9, 675 pages, 452 illustrations, 3 plates\$5.00

Here is a work so complete, and elementary, that almost anyone interested in practical structural work can get from it a thorough knowledge of its principles and practice.

For many years the author was required to "break in" new men in draughting and designing rooms, and this has taught him the needs of the man who requires a workable knowledge of the subject.

Nothing but elementary mathematics is presupposed. As the author says in his preface, the book was designed to be understood without the aid of a library of reference works.

There are fourteen chapters as follows: I, Preliminary; II, Structural Drafting; III, Fundamental Elements; IV, Theoretical Treatment of Beams; V, Theoretical Treatment of Columns; VI, Rivets, Pins, Rollers and Shafting; VII, Maximum Reactions; VIII, Graphic Statics; IX, Influence Lines; X, Descriptions of I-Beams and Plate Girders; XI, Design of Simple Railway Bridges; XII, Design of Simple Highway Bridges; XIII, Skew Bridges; XIV, Design of Buildings.

MELAN'S THEORY OF ARCHES AND SUSPENSION BRIDGES

Translated by **D. B. Steinman**, C. E. Ph.D., Prof. of Civil Engineering, Univ. Idaho, author of "Suspension Bridges and Cantilevers"

Cloth, 6 x 9, 310 pages, 120 illustrations\$3.00

This is a complete, authorized translation of Professor Melan's masterpiece on the theory of arches.

Contents

The Flexible Arch and the Unstiffened Cable; The Stiffened Suspension Bridge; The Arched Rib (the Three Hinged Arch, Arched Rib with End Hinges, Arched Rib without Hinges, The Cantilever Arch, the Continuous Arch); Arch and Suspension Systems with Braced Web; Combined Systems; Appendix—The Elastic Theory Applied to Masonry and Concrete Arches, Temperature Variation in Steel and Masonry Bridges.

Engineering News: "It is by far the most extensive theoretical study of this subject known to the reviewer."

Journal Western Society of Engineers: "Professor Steinman has done a great service to all English speaking engineers in translating this treatise on Arches and Suspension Bridges by Professor Melan. The German method of starting at the beginning and taking nothing for granted is followed. In the opening chapters a masterly exposition of the conditions of statical determinacy and indeterminacy is given, as also the general forms into which hinged and fixed arches may be resolved. The book deserves a place in the library of every practising engineer who has anything to do with structures of any kind, and will amply compensate him for all time devoted to the study of its pages."

DIAGRAMS FOR THE DESIGN OF REINFORCED CONCRETE STRUCTURES

By **G. F. Dodge**

Cloth, 15½ x 12½, 112 pages, 43 diagrams\$4.00

Founded on diagrams prepared by the author for his own use when employed as a designing engineer by a reinforcing company. No experience in mathematics required by those who do their designing from this book.

Table of Contents

Formulæ and Discussion; Straight Line Variations of Stress; Slabs; Cinder Concrete; Rectangular Beams; T Beams; Compressive Reinforcement; Hooped Columns, Ultimate Loads; Hooped Columns, Working Loads; Parabolic Variation of Stress, Ultimate Loads; Slabs; Rectangular Beams.

Miscellaneous—Deflections; Impact; Weight and Volumes of Beams, Columns and Slabs, Reactions and Strengths of Steel Beams; Bending Moments of Beams and Channels in ft.-lbs.; Bending Moment and Shear Formulæ; also contains numerous diagrams; Appendix.

CLARK BOOK CO., INC., 27 William Street, New York City

MILL BUILDINGS DESIGN AND CONSTRUCTION

With Chapters comparing the costs of steel, wood and concrete buildings, and on exporting steel buildings

By Henry Grattan Tyrrell, C. E., author of *Mill Building Construction, Concrete Bridges and Culverts, History of Bridge Engineering, Artistic Bridge Design, etc.*

Cloth, 6 x 9, 490 pages, 652 illustrations, with chapter comparing wood, steel and concrete buildings \$4.00

The final efficiency of an industrial plant depends not merely upon the proper design of structural members, but also upon a great variety of special problems which might be classified as the economics of design.

"Mill Buildings" thoroughly covers the latter as well as the former, in fact it is this thorough treatment of the economic feature which distinguishes the book from others on the same subject.

Chapter Headings

General Features and Requirements of Economic Design; Location and Site; Purpose and Arrangement; Number of Stories; Walls; Cost of Steel Buildings; Comparative Cost of Wood, Steel and Concrete Buildings; Roof Covering and Drainage; Lighting and Ventilating; Static Roof Loads; Floor Loads; Snow and Wind Loads; Crane and Miscellaneous Loads; Steel Framing; Wood Framing; Concrete Framing; Northern Light Roof Framing; Foundations and Anchorages; Wall Details; Ground Floors; Upper Floors; Metal Arch Floors; Roofs, Non-Waterproof; Roofings, Tile, Slate, Asbestos, Slate, Wood, Composition Roofing; Corrugated Iron; Sheet Metal Roofing; Cornices, Gutters and Downspouts; Ventilators, Glass, Skylights, Windows; Monitor Windows, Doors; Factory Foot Bridges; Paint, Painting; Painting Specifications for Structural Steel Work; Engineering Department; Estimating the Quantities; Estimating the Costs; Approximate Estimating Prices; The Drafting Office; Organization of Drafting Office; Drafting Office Practice; Cost of Structural Work Shop Drawings; Directions for Exporting Steel Buildings.

ARTISTIC BRIDGE DESIGN

By Henry Grattan Tyrrell, C. E., author of *Mill Building Construction, Concrete Bridges and Culverts, History of Bridge Engineering, and Mill Buildings.*

Cloth, 6 1/4 x 9 1/4, 290 pages, illustrated \$3.00

Long after the cost of a bridge is forgotten, its appearance stands for or against its designer, and this book is designed to help the engineer or architect who realizes this, to combine beauty, utility and economy in his work.

The work is divided as follows:

| Subject. | Pages. |
|---|--------|
| Introduction by Thomas Hastings, Importance of Bridges, Reasons and Standards for Art in Bridges, Causes for Lack of Art, and Special Features of Bridges | 34 |
| Principles of Design | 15 |
| Ordinary Steel Structures | 6 |
| Cantilever Bridges | 6 |
| Metal Arches | 16 |
| Suspension Bridges | 10 |
| Masonry Bridges | 24 |
| Illustrations and Descriptions | 157 |

These last are taken from representative structures all over the world, covering the general classes mentioned above. The illustrations alone justify the book.

America has the reputation for having "the greatest number of bridges, and the ugliest." Mr. Tyrrell's work is an effort to reform the policy that has given us this record.

FIELD SYSTEM

By Frank B. Gilbreth

Handbook size and binding, 200 pages \$3.00

Mr. Gilbreth made the "Cost-plus-a-fixed-sum" contract famous. This "Field System" is the book of instructions issued to all his foremen, superintendents, time and material clerks, accounting departments, etc. *Value-able rules for running a job.*

CLARK BOOK CO., INC., 27 William Street, New York **CNY**

STEEL BRIDGE DESIGNING

By Melville B. Wells, C. E., Asscc. Prof. Bridge & Struc. Eng., Armour Inst. Technology

Cloth, 6 x 9 inches, 250 pages, 47 illustrations, 27 folding plates... \$2.50
A text book for engineering students and a reference work for designing offices.

The twenty-seven folding plates, which are reproductions of actual drawings taken from standard practice, make the book especially valuable.

Another valuable feature, especially for the draughting room, is the copy of the general specifications for steel railway bridges, adopted by the American Railway Engineering Association, elaborately cross indexed in this book.

Chapter Headings

Engineers' Work and Contracts, Bridge Manufacture; Rivets; The Design of a Roof Truss; Types and Details of Highway Bridges; Design of a Riveted Truss Highway Bridge; Types and Details of Railway Bridges; Design of a Plate Girder Railroad Bridge; Design of a Riveted Truss Railroad Bridge; A Pin Connected Bridge; Shop Drawings; Strength of Materials; Bibliography; Specifications.

CONCRETE CONSTRUCTION, METHODS AND COST

By H. P. Gillette, Consulting Engineer, and Charles S. Hill, Associate Editor of *Engineering and Contracting*

6½ x 9¼, cloth, 690 pages \$5.00
Devoted to the economics of concrete for the builder of concrete structures. The authors are constantly in touch with the best and cheapest methods of concrete construction; Mr. Gillette, through his field work, and Mr. Hill, as editor of *Engineering and Contracting*.

CHAPTERS:—Methods and Cost of Selecting and Preparing Materials for Concrete; Theory and Practice of Proportioning Concrete; Making and Placing Concrete by Hand; Making and Placing Concrete by Machine; Depositing Concrete Under Water and of Subaqueous Grouting; Making and Using Rubble and Asphaltic Concrete; Laying Concrete in Freezing Weather; Finishing Concrete Surfaces; Form Construction; Concrete Pile and Pier Construction; Heavy Concrete Work in Fortifications, Locks, Dams, Breakwaters and Piers; Constructing Bridge Piers and Abutments; Constructing Retaining Walls; Constructing Concrete Foundations for Pavement; Constructing Sidewalks, Pavements, Curbs and Gutters; Lining Tunnels and Subways; Constructing Arch and Girder Bridges; Culvert Construction; Reinforced Concrete Building Construction; Building Construction of Separately Molded Members; Aqueduct and Sewer Construction; Constructing Reservoirs and Tanks; Constructing Ornamental Work; Miscellaneous Methods and Costs; Waterproofing Concrete Structures.

ENGINEERS' POCKETBOOK OF REINFORCED CONCRETE

By E. Lee Heidenreich, Mem. Am. Soc. Test. Materials; M. W. S. E.; Mem. Am. Inst. Min. Eng.

Flexible leather, 374 pages, 4½ x 6¾ inches, 80 tables, illustrated... \$3.00

Here is the "Trautwine" of reinforced concrete, the product of the author's 15 years' experience in the design and construction of reinforced concrete.

The tables and formulæ were designed particularly to save time in the draughting room, not simply inserted as detached bits of information.

The formulæ are not simply stated, but developed and illustrated with examples as well, so that the beginner or "rusty" mind can grasp them readily.

Chapter Headings

Materials and Machines Used in Concrete Construction; Design and Construction of Buildings; Design and Construction of Bridges; Abutments and Retaining Walls; Culverts, Conduits, Sewers, Pipes and Dams; Tanks, Reservoirs, Bins and Grain Elevators; Chimneys. Miscellaneous Data.

Engineering News: "Mr. Heidenreich's pocket-book is nearer the ideal than any on the same subject heretofore published."

CLARK BOOK CO., INC., 27 William Street, New York City

WALKER'S BUILDING ESTIMATORS' REFERENCE WORK

By Frank E. Walker, a Contractor

Flexible leather, handbook size, 1600 pages\$5.00

This is a practical and thoroughly reliable reference book for contractors and estimators engaged in estimating the cost of and in constructing all classes of modern buildings.

It gives the actual labor costs and methods employed in the erection of some of our present day structures, together with all the necessary materials, prices and labor quantities entering into the costs of all classes of buildings.

Contents

General Conditions and Overhead Expense; Wrecking and Excavating; Caissons; Lagging and Concrete; Wood and Concrete Piles; Concrete for Footings and Foundations; Water and Damp Proofing; Concrete Floors and Pavements; Reinforced Concrete Construction; Brick Masonry; Rubble Work, Cut Stone, Granite and Architectural Terra Cotta; Hollow Tile Fireproofing; Rough Carpentry; Timber Framing, Lumber, Flooring, etc.; Mill Work and Interior Finish; Plastering; Fire Retarding Doors and Windows; Sheet Metal Work, etc.; Roofing, Slate, Tile, Composition, etc.; Exterior and Interior Models, Slate or Scagliola; Interior Tiling, Floors, Wainscoting, Mantels, etc.; Glass and Glazing; Painting and Varnishing; Structural Iron and Steel; Miscellaneous and Ornamental Iron, Brass and Bronze; Miscellaneous Building Specialties, Vault Doors, Prismatic Sidewalk Lights, Blackboards, etc.; Rough and Finish Hardware; Plumbing, Sewerage and Gas Fitting; Steam and Hot Water Heating, Electric Wiring.

BRICKLAYING SYSTEM

By Frank B. Gilbreth, Mem. Am. Soc. M. E.

Cloth, 6 x 9 inches, 330 pages, 167 illustrations, 73 bond charts . . . \$3.00

This book was written by one of the largest general contractors in New York, for his own foremen and superintendents, but is vastly more than a mere rule book.

It is the application of the new movement for more science in management, to bricklaying in particular, but its principles are applicable to the entire building and engineering industry.

Brick costs must be reduced if brick is to hold its place as a building material in the face of concrete's competition. Gilbreth's "Bricklaying System" is a great help in this direction.

There is no contractor doing brick work who is not vitally interested in the reduction of costs, and "Bricklaying System" can help him, unless he already knows all there is to be known.

Chapter Headings

Training Apprentices; Methods of Management; Methods of Construction; Routing of Material; Scaffold, The Gilbreth Scaffold, Hod Type; the Gilbreth Scaffold, Packet Type; The Gilbreth Packet System; Method of Building Tall Chimneys; Mortar; Bricks; Bricklayers' Tools, etc.; Lines, Plumbs and Poles; Motion Study; Methods of Laying Brick Under Special Conditions; Finishing, Jointing and Pointing; Arches and Chimney Breasts; Tearing Down, Cutting Out and Patching Brickwork; Bond.

INSPECTION OF CONCRETE CONSTRUCTION

By Jerome Cochran

Cloth, 6 x 9, 595 pages, illustrated\$4.00

Covers over 200 different special subjects under concrete, elaborately indexed for quick reference. An encyclopedia for the inspector, engineer, superintendent or foreman on concrete work.

Chapter Headings

Inspection of Hydraulic Cement; Inspection of Sand, Stone, etc., Inspection of Proportioning and Mixing; Inspection of Forms, Molds, Centering, etc.; Inspection of Steel Reinforcement; Inspection of Concrete; Inspection of Surface Finishes; Inspection of Waterproofing; Inspection of Sidewalks, Curbs and Pavements; Inspection of Ornamental Work, Blocks, etc.; Inspection of Molding and Driving Concrete Piles; Definition of Terms, List of Authorities, Index.

CLARK BOOK CO., INC., 27 William Street, New York City

